



Sika Facade Systems Sealing and Bonding in Facades – Specification Guide



Innovation & Consistency | since 1910





Contents

Introduction

High-tech facades	5
--------------------------	----------

Glazing Technologies

Four-sided structural glazing	6
Two-sided structural glazing	6
Bolt-fixed glazing	7
Total vision glazing	7

Structural Glazing SG

SG modular design	8
Joint design and calculation	10
Support beyond formulas	14
Facade system components – Glass and Metal	15
SG silicone adhesive sealants	16

Insulating Glazing IG

IG modular design	18
Seal height calculations	20
IG secondary sealants	22
Gas-filled IG units	23

Weathersealing WS

Joint design	24
WS silicone sealants	24
Natural stone sealants	26
Total vision glazing	28
Fire-rated sealing	29

Vapour Proofing

Facade membrane systems	30
--------------------------------	-----------

Ancillary Products

Surface treatment	32
Cleaner, primer	32
Spacer tapes	33

FFI Competence Centre FCC

Project service	34
Comprehensive quality management	35
Project testing	36
Project procedure: workflow	37
Technical glossary	38



Sika's Sealing and Bonding Solutions – for Facades in every Climate



Projects on this page:

- 1 Peek & Cloppenburg Store, Cologne, Germany
- 2 30 St. Mary Axe, London, UK
- 3 Zhang Jiang Hi-Tec Park, Shanghai, China
- 4 New Exhibition Center Milan, Italy
- 5 University of Chicago, USA
- 6 Jiangsu Telecom Building, Nanjing, China
- 7 Crystal Tower, Manama, Bahrain
- 8 Russia Federation Tower, Moscow, Russia
- 9 One Marina Boulevard (NTUC Building), Singapore

Front page:
Drugstore Publicis, Paris, France



High-Tech Solutions for Perfect Facades

Architecture thrives on change. On creative ideas and bold solutions that fascinate and surprise us every time. Curtain walls are a particularly severe challenge for planners, because they not only set the character of the structure but must also meet stringent requirements.

Creative Facade Architecture

To strike the ideal balance between aesthetic appeal and energy efficiency, architects are increasingly turning to glass for curtain wall construction. As transparent structural glazing walls, single or double glazed or even double skin facades. Glass can also be combined with other materials such as natural stone, metals or plastic coated metals, giving planners a wide scope for creativity.

But an immaculate optical appearance isn't the only crucial factor. Facades and windows must provide long-term durable systems. This requires perfect adhesion between the components and highly elastic, weatherproof seals. These specifications call for high-tech silicone sealants, which are tailored to meet highly specific demands and guarantee peak performance in every respect.

With this application in mind, Sika supplies a wide range of tried-and-tested, innovative facade products for every demand:

Sikasil®. Each of these sealants and adhesives has highly specific properties that are precisely tailored to the particular application. From structural glazing and insulating glass secondary seals through to weatherseals.

SikaMembran® membrane systems supplement ideally the sealants range for water/vapour proofing wide joints in both curtain wall and ventilated facades.



For structural glazing silicone adhesive sealants Sikasil® SG see page 16.

Four-Sided Structural Glazing

Optimum Transparency

Structural glazing systems can be either two-sided or four-sided, with each design having its own particular advantages. In general, for efficient and energy-saving building management, double glazing is recommended.

Frameless Appearance

Four-sided structural glazing is impressive first and foremost because of its monolithic frameless appearance. All four sides of the large-format pane element are bonded to an adapter frame with Sikasil® SG silicone adhesive sealants and have no visible frame. These prefabricated glass modules are subsequently attached to the support structure so that the facade gives the appearance of a flat glass surface.

The dynamic loads are transmitted through the silicone adhesive. To support the dead load of the glass, we recommend a mechanical support that is not visible from the outside.

Advantages of this System

- Attractive appearance without visible frames
- Thanks to its high elasticity, the silicone sealant can transmit the loads at all four sides more efficiently and uniformly
- Temperature distribution in the glass is ideal, since there are no cap profiles, which would act as shades. This reduces the risk of glass breakage caused by thermal stresses
- The facade is more energy-efficient as there are no external metal parts and all joints are sealed
- Greater self-cleaning from level glass

Two-Sided Structural Glazing

Optimum Safety

Mechanical Fixing

In the two-sided structural glazing system, only two mutually opposite glass or panel edges are bonded (horizontally or vertically) to a frame with Sikasil® SG silicone adhesive. The two other mutually opposite sides are fixed mechanically like capped CW systems.

Mechanical fixing of the glass element at two sides does not affect the loads on the two bonded sides. Since excessive bending of the glass must be prevented, the minimum dimensions of the joint must not be changed compared to a four-sided system.

Advantages of this System

- High mechanical safety
- The silicone adhesive and the mechanical fasteners help distribute the dynamic forces
- Metal cap profiles can be used as design elements to make the facade seem less severe





28

For UV-resistant weather sealing between the glass panes with Sikasil® WS silicones see page 24.



29

For the appropriate fin glazing silicone sealants Sikasil® SG and Sikasil® WS see page 28.

Bolt-Fixed Glazing

The Lightness of Glazing

Mechanical Fixing

In bolt-fixed glazing systems, the glass elements are fixed to cable systems or metal beams by metal fasteners. These fasteners are embedded in holes in the glass pane with "glass cement". The glasses can be single panes (e.g. laminated glass in the outer skin of the double skin facade) or insulating units with UV-resistant silicone edge sealing and even with argon filling (Sikasil® IG).

Advantages of this System

- High mechanical safety
- Lightweight glass constructions feasible

For the embedding of the metal fasteners into the glass holes and perfect levelling of production tolerances please ask for the Sika® AnchorFix® series.

Total Vision Glazing

Frameless Appearance

Impressive Glass Heights

Total vision glazing (fin glazing) impresses by its even frameless appearance and the huge glass sizes.

Total vision glazing resembles two-sided structural glazing where the top and bottom glass edges are embedded in the ceiling and floor slab. The vertical glass edges are structurally bonded to the glass fins.

Advantages of this System

- Attractive appearance without visible frames
- Thanks to its high elasticity, the silicone sealant can transmit the loads more efficiently and uniformly
- Temperature distribution in the glass is ideal, since there are no cap profiles, which would act as shades. This reduces the risk of glass breakage caused by thermal stresses



Stock Exchange; Johannesburg, South Africa



Zorlu Plaza, Istanbul, Turkey

Structural Glazing – Sophisticated Architecture and Innovative Technology

Structural glazing modules are subject to extremely high stresses. They must accommodate wind and snow loads as well as thermal expansion, and permanently transfer the forces to the support structure, while also withstanding weathering over many years.

Specialized Products

High-modulus Sikasil® SG silicone adhesive sealants offer the best properties for this purpose. Sika's low-modulus Sikasil® WS weatherseals accommodate the movements between the structural glazing modules and durably seal them against wind and weather. The elastic seal can even reduce damage in small to medium-scale earthquakes and bomb blasts.

Durable Construction

Sikasil® SG silicone adhesive sealants are used in structural glazing for bonding the glass elements to the metal support frames. The elements may be designed as single glazing or insulating glazing to provide an insulating facade, which forms the complete building envelope and guarantees excellent corrosion protection. Coated multifunctional insulating glazing provides the necessary protection against the sun. Other variants include double skin facades produced with single glazing elements. The elastic joints produced with Sikasil® SG silicone adhesives accommodate movements of the construction elements resulting from temperature changes, moisture, shrinkage of construction materials, sound, wind and vibrations. Permanently.



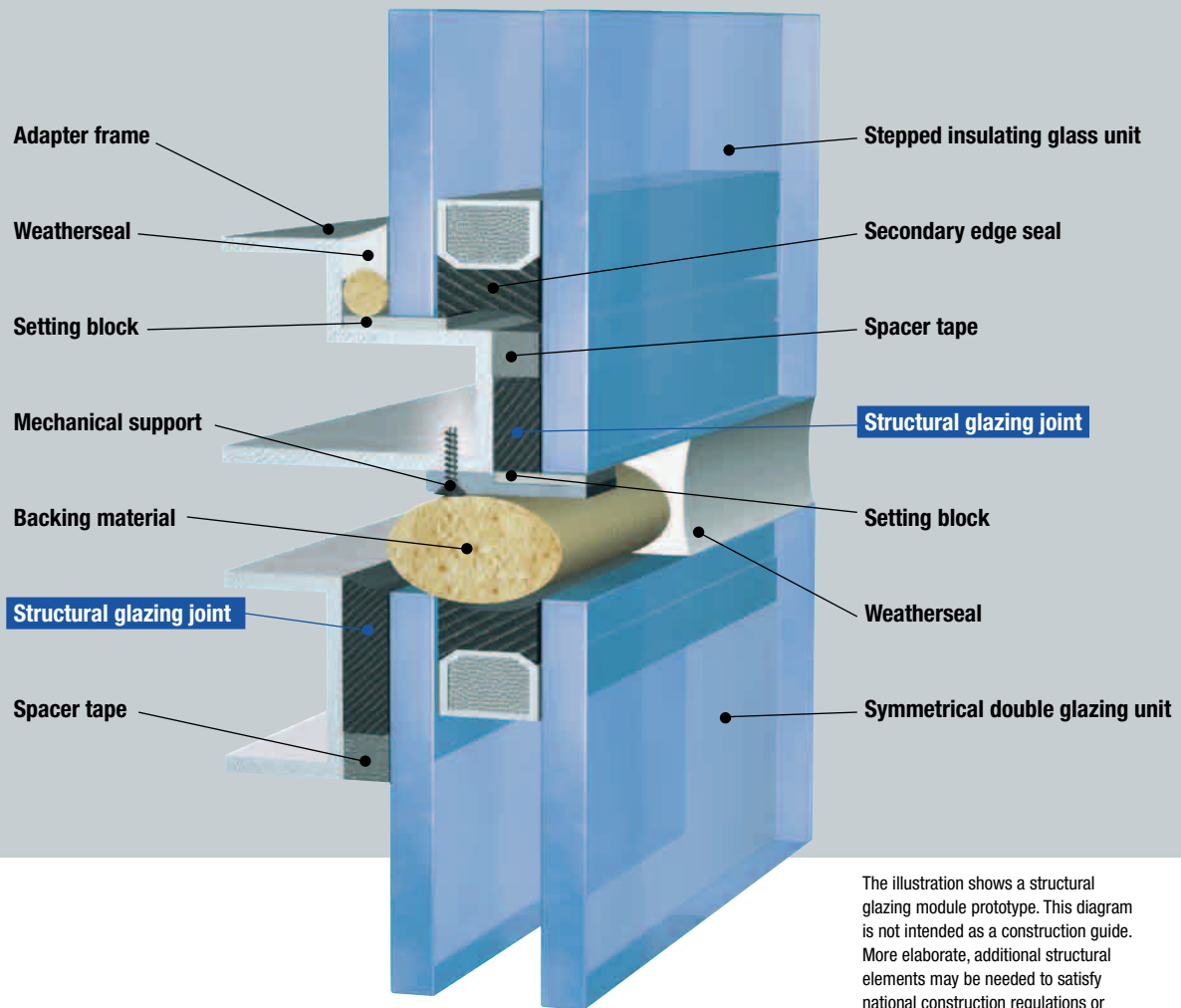

The illustration shows a structural glazing module prototype. This diagram is not intended as a construction guide. More elaborate, additional structural elements may be needed to satisfy national construction regulations or project-specific requirements.

Economical Construction

Structural glazing facades have both technical and economical advantages:

- The factory-produced units can be installed quickly and economically
- An efficient insulating facade slashes thermal losses, providing a much improved energy balance
- High solar heat recovery can be taken into account in the energy balance
- Acoustic insulation is improved by insulating glazing and elastic silicone sealant
- These easy to clean facades have low maintenance and cleaning costs
- Repairs can be carried out much more economically by quick and easy module exchange

Integrated Systems

A fully integrated structural glazing system is only possible if a number of conditions are met:

- Project-specific computation of the joint dimensions so that the system can be perfectly executed down to the last detail
- Factory bonding of the industrially manufactured glass modules with extreme positional accuracy
- Frame construction exactly tailored to the type of facade
- Sealants and weatherseal gaskets of high-quality silicones, which meet the strictest construction regulations and international standards
- Stringent quality control on all the products used, from production through to application



Airport Barajas Madrid, Spain; Richard Rogers & Estudio Lamela

Joint Design – Correct Planning is Essential

In structural glazing, the adhesive joints should be planned and arranged according to optical requirements, but they should also take into account dimensional changes in the adjacent parts under the effect of temperature and the movement capability of the silicone adhesive. The joint design thus combines shape with functionality.

Important

Seven criteria must be observed:

1. The joint seal must be able to freely accommodate tensile and compressive movements between the joint edges. Three-sided adhesion of the sealant must be avoided, because it inevitably results in damage to the joint (see fig. on page 13).
2. The joint bite h must not exceed 15 mm for Sikasil® SG-18 and Sikasil® SG-20. For bigger joints up to 50 mm, use Sikasil® SG-500 or Sikasil® SG-500 CN.
3. The ratio of joint bite h to joint thickness e should be at least 1:1 and at most 3:1.
4. The minimum joint bite is always 6 mm, irrespective of the calculated value.
5. The joint thickness e should be at least 6 mm.
6. Always round the result up, never down.
7. The structural joints must not be subjected to external loads as a result of forces such as settlements, shrinkage, creep or permanent stress caused by gaskets etc.

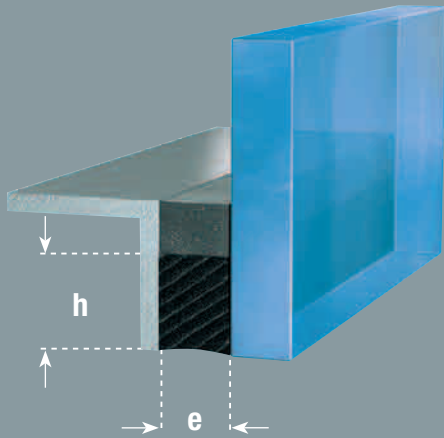

h joint bite
e joint thickness



Calculating the Joint Bite h

Typical Stress/Strain Diagram of Sikasil® SG-500

Force [N]

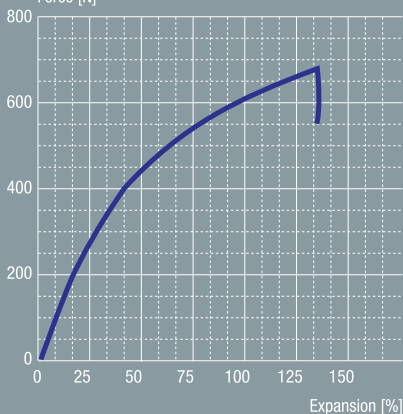

Joint bite h as a function of the wind load in supported constructions:

$$h = \frac{a \times w}{2 \times \sigma_{\text{dyn}}}$$

- h = minimum bite of the adhesive joint (mm)
- a = length of the short edge of the glass pane or of the element (mm); with irregularly dimensioned glass elements: longest of the short glass panes¹⁾
- w = maximum wind load to be received (kN/m²) (100 kp/m² = 1 kPa = 1 kN/m²)
- σ_{dyn} = maximum adhesive stress for supported constructions (kPa)
 - Sikasil® SG-500: 140 kPa = 0.14 N/mm²
 - Sikasil® SG-500 CN: 140 kPa = 0.14 N/mm²
 - Sikasil® SG-550: 200 kPa = 0.20 N/mm²
 - Sikasil® SG-20: 170 kPa = 0.17 N/mm²
 - Sikasil® SG-18: 140 kPa = 0.14 N/mm²

¹⁾ If the sides of the glass panes are of varying length, then the length of the longest side is used for the calculation.

Example 1 (with Sikasil® SG-500):

Maximum wind load = 4.0 kN/m²
 Pane dimensions: 2.5 m × 1.5 m
 Result = 21.43 mm
 The joint bite is thus at least 22 mm.

Joint bite h as a function of the dead load in non-supported constructions:

$$h = \frac{G \times 9.81}{l_v \times \tau_{\text{stat}}}$$

- h = minimum bite of the adhesive joint (mm)
- G = weight of the glass or of the element (kg)
- l_v = length of the vertical adhesive bond (m)
- τ_{stat} = permissible stress of the adhesive for non-supported constructions (kPa)
 - Sikasil® SG-500: 10.5 kPa = 0.0105 N/mm²
 - Sikasil® SG-500 CN: 10.5 kPa = 0.0105 N/mm²
 - Sikasil® SG-550: 13.0 kPa = 0.013 N/mm²
 - Sikasil® SG-20: 12.8 kPa = 0.0128 N/mm²
 - Sikasil® SG-18: 9.5 kPa = 0.0095 N/mm²

Example 2 (with Sikasil® SG-500):

Pane dimensions: 3 m × 1 m × 12 mm
 Density of glass: 2.5 kg/dm³
 Result: 14 mm

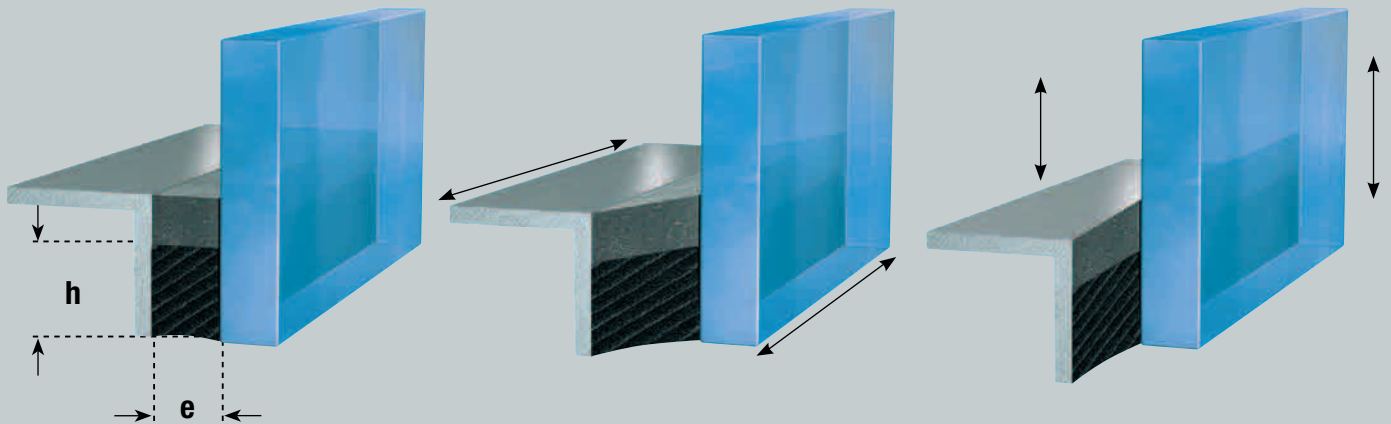

Right joint dimension in its original state
(h = joint bite, e = joint thickness)

Besides tensile movements the adhesive bond also absorbs
shear movements in all directions.

Calculating the Joint Thickness e

With all structural glazing constructions, the adhesive bond is subject to considerable shear movements. The joint thickness (glue line thickness) must therefore be designed so that the movement capability is not exceeded.

Criteria for Calculating the Joint Thickness e

- Dimensions of the elements
Maximum temperature differences to be expected
- Coefficients of thermal expansion of the materials to be bonded
Estimated value for joint thickness:
half of joint bite, at least 6 mm

Please note that

1. All causes of movement must be taken into account:
 - Thermal effects due to different coefficients of thermal expansion between the glass and the support structure. If the joint dimensions are to be the same for a complete construction project, they must be calculated according to the dimensions of the largest pane
 - Other causes, such as shrinkage, subsidence or locally confined stresses
2. Observe all tolerances. These include the tolerances for cutting glass, and/or metal, and installation tolerances
3. The application temperature must be between +5 °C and +40 °C
4. Avoid three-sided adhesion of the sealant so as not to restrict joint movement

1. Deformation of the SG Structure

$$\Delta l_{v,h} = l_{v,h} \times [(\alpha_f \times \Delta T_f) - (\alpha_g \times \Delta T_g)]$$

Calculation of the deformation of the long and short panel edges to take account of the different expansion and contraction of glass and adapter frame (thermally induced movements in the shear direction).

- $\Delta l_{v,h}$ = change in length (mm)
- l_v = vertical length of the glazing unit (mm)
- l_h = horizontal length of the glazing unit (mm)
- T_f = average temperature difference of the frame (approx. 30 – 60 K)
- T_g = average temperature difference of the glass (approx. 30 – 60 K)
- α_f = expansion coefficient of the frame material (aluminium: $23.8 \times 10^{-6} \text{ K}^{-1}$, steel: $12 \times 10^{-6} \text{ K}^{-1}$)
- α_g = expansion coefficient of the glass
 $9 \times 10^{-6} \text{ K}^{-1}$



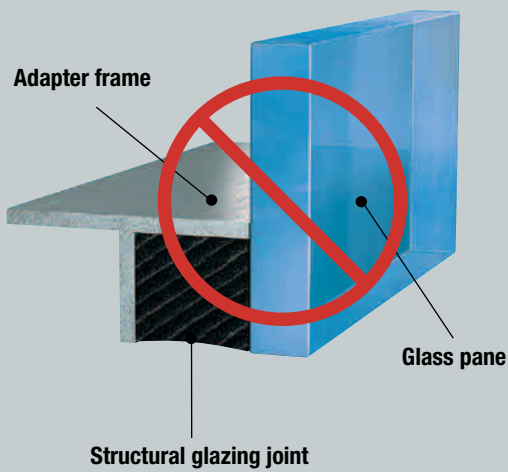

It is essential that bonding on three sides is avoided.



2. Total Movements

$$\Delta l = \sqrt{\Delta l_v^2 + \Delta l_h^2}$$

The calculated deformations of the long and short panel edges yield the total movements according to the formula above (Pythagoras' theorem).

Δl = total change in length
 v = vertical
 h = horizontal

3. Calculation of the minimum Joint

Thickness e

$$e \geq \frac{\Delta l}{\sqrt{2c + c^2}}$$

Sikasil® SG silicone adhesive sealants are permitted maximum elongation of 12.5% ($c = 0.125$). The total of expansion and contraction must not exceed 25%. With these restrictions, the minimum joint depth e can be calculated.

This calculation complies with ASTM C1401. EOTA ETAG No.002 (2004) Annex 2 describes another calculation method based on shear modulus.

For support in joint calculations please contact our Sika FFI Competence Centre.

Example 3:

Pane dimensions: 2.5 m × 1.5 m

(see example 1)

Temperature difference aluminium frame: 60 K

Temperature difference glass: 30 K

Maximum elongation: 12.5% ($c = 0.125$)

Result: $e \geq 6.56$ mm

Since the ratio of the joint bite h (22 mm, example 1) to the joint thickness e is supposed to be smaller than 3:1, a joint thickness of at least 7.33 mm has to be chosen. A standard spacer tape thickness for this would be 8 mm.

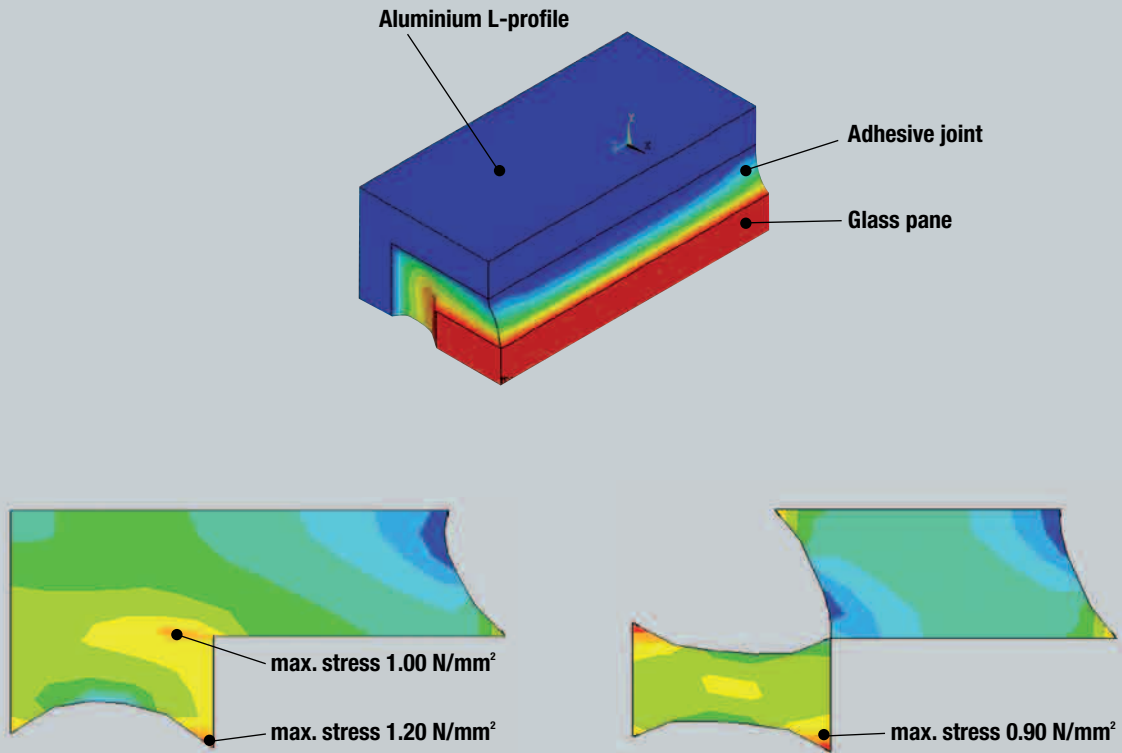

Example for FE calculation: L-joints request special care due to high stresses in corners (left). The use of a backer rod reduces the ultimate stress by more than 30% (right).

Support Beyond Formulas

Finite Element Calculations

Joint design becomes more complex, joint sizes get smaller and smaller, loads and movements go to the extremes. Our specialists in the FFI Competence Centre in Switzerland accompany trends and developments not only with sophisticated tests but also with the latest methods of finite element calculations.

High Speed Tests for Bomb Blast and Hurricane Resistance

For Sika as one of the market leaders in the automotive and transportation industry high speed tests are state-of-the-art tests at its high-tech laboratories. Before any crash test or bomb blast test we measure high speed impact on sealants and adhesives on small specimens. Based on these values we help to optimize the joint dimensions.

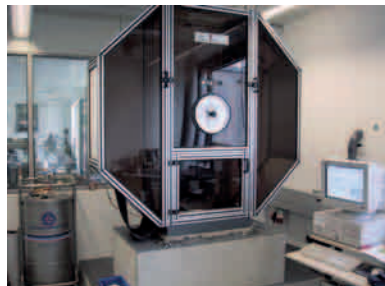

Impact test machine with pendulum (ISO 11343) for velocities of 1.10 m/s – 5.24 m/s at temperatures from –50 to +80°C. As glass deforms with a max. speed of 4 m/s, this is the optimal range for simulating bomb blast tests.

Tensile Shear Strength as a Function of Velocity

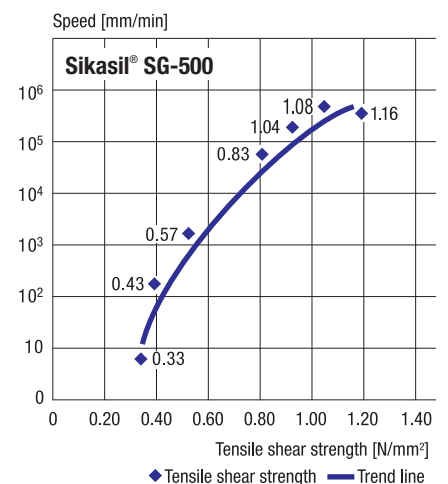

The higher the impact speed, the higher the adhesive's tensile strength, the higher the design factor.





80 and 100 Victoria Street London, UK; EPR Architects

Facade System Components – Glass and Metal Frame

Glass

1. Uncoated Float Glass

Float glass is generally suitable for all bonded glass facades. To reduce the risk of damage from glass breakage, use tempered or laminated glass (with polyvinyl butyral film, PVB or cast resins). Sikasil® SG silicone adhesives ensure excellent adhesion to tempered glass without additional tests. Where laminated glass is used, we recommend carrying out compatibility tests.

2. Pyrolytic Coatings for reflective Glass (hard Coatings)

Coated glass optimizes the thermal insulation of the facade while providing a particularly attractive optical effect. Pyrolytic coatings (hard coatings) of metal oxides are ideal for structural glazing, since they resist environmental conditions.

For Sikasil® SG silicone adhesives, we only offer a warranty for adhesion after we have conducted individual adhesion tests.

3. Magnetron Coatings for lowE Glass (soft Coatings)

These coatings contain precious metals (such as silver) and are generally not resistant enough for use in structural glazing bonds. If necessary, strip off the coating around the bond. Adhesion should therefore be tested on the abraded specimens, since abrasion represents a modification of the surface, and is subject to various parameters. Always observe the glass manufacturer's instructions.

4. Ceramic Coatings

Ceramic coatings are used predominantly in the spandrel area. At the edge regions of the glass, they cover colour differences within the insulating glazing edge seal and between the edge seal and the structural glazing adhesive. The adhesive strength of Sikasil® SG silicone adhesives has been proven in numerous projects and tests according to the European guideline for bonded glass structures (EOTA ETAG No. 002).

However, since the composition of the coatings may vary greatly, the warranty requires that individual tests be carried out for each project.

Adapter Frame

The adapter frame is usually made of the following materials:

- Anodized aluminium**
- Powder-coated aluminium**
- PVDF-coated aluminium**
- Stainless steel**

Sikasil® SG silicone adhesives and Sikasil® WS sealants adhere very well to these materials, but Sika carries out additional tests to check this separately for every individual project. Sika® Aktivator-205 (Sika® Cleaner-205) and Sika® Primer-790 optimize adhesion on critical materials.

Sikasil®	SG-18	SG-20	SG-500	SG-500 CN
Components	one-part	one-part	two-part	two-part
Curing system	neutral	neutral	neutral	neutral
Processing	with guns from cartridges or foil packs	with guns from cartridges or foil packs	machine mixing	machine mixing
Installation of bonded elements	after 2 to 4 weeks ¹⁾	after 2 to 4 weeks ¹⁾	after 3 to 5 days ¹⁾	after 3 to 5 days ¹⁾
Maximum of joint bite [mm]	15	15	50	50
Skin forming time/pot life (23° C/50% rel. humidity) [min]	~ 30	~ 15	~ 50	~ 60
Permanently elastic range [°C]	-40 to +150	-40 to +150	-40 to +150	-40 to +150
Shore A hardness ²⁾	~ 44	~ 39	~ 45	~ 40
Tensile strength ³⁾ [N/mm ²]	~ 1.06	~ 1.20	~ 0.95	~ 0.9
Modulus at 100% elongation ³⁾ [N/mm ²]	~ 0.81 (50%)	~ 0.90 (100%)	~ 0.95 (100%)	~ 0.9 (100%)
Elongation at break [%]	~ 75	~ 180	~ 100	~ 120
Design stress in tension [N/mm ²]	0.14 ⁴⁾	0.17 ⁵⁾	0.14 ⁵⁾	0.14 ⁴⁾

1) Depends on joint dimensions and curing conditions, 2) ISO 868, 3) ISO 8339-A, 4) Acc. ASTM C1184 5) Acc. ETA.

These figures are intended as a guide and should not be used in preparing specifications. For technical information about the products, please ask for the latest respective data sheets.

Sikasil® SG Silicone Adhesives – Systems with Individual Advantages

Structural Bonding

Sika has developed one-part and two-part silicone adhesive sealants for structural glazing and insulating glazing applications, and each feature specific advantages.

Which of these systems is best for a particular application depends first and foremost on the specific requirements. Both systems offer maximum quality and maximum safety in every respect.

In addition they are characterized by the following special properties:

High tensile strength

High tear resistance

High elastic recovery

Low volume shrinkage on curing

Sikasil® SG-500

- Two-part SG system
- For machine application
- Neutral curing
- Fast vulcanization and through-cure
- Excellent UV and weathering resistance
- High mechanical strength
- ETA certified and CE-marked

Sikasil® SG-500 CN

- Two-part SG system
- For machine application
- Neutral curing
- Fast vulcanization and through-cure
- Excellent UV and weathering resistance
- High mechanical strength

Ask Sika for the latest SG Application Guidelines

Sikasil® SG-550

- Two-part SG system
- For machine application
- Neutral curing
- Fast vulcanization and through-cure
- Excellent UV and weathering resistance
- Very high mechanical strength
- High design stress for small SG joints
- ETA certified and CE-marked

Did you know?

With 0.20 N/mm² Sikasil® SG-550 achieves the highest ETA approved design stress in tension in the market.



SG-550

two-part

neutral

machine mixing

after 3 to 5 days ¹⁾

50

~ 60

-40 to +150

~ 55

~ 1.6

~ 1.0 (25%)

~ 80

0.20 ⁵⁾



Pfizer Headquarters, Walton Oaks, Surrey, UK

Sikasil® SG-18

- One-part SG system
- Neutral curing
- Ready to process
- High mechanical strength
- High modulus
- UV-resistant and weather-resistant

Sikasil® SG-20

- One-part SG system
- Neutral curing
- Odourless
- Ready to process
- Very high mechanical strength combined with high elasticity
- UV-resistant and weather-resistant

Standards and Guidelines

A wide variety of local standards and guidelines have become established worldwide. The most important are:

In Europe

EOTA ETAG No. 002-2004: a guideline on the application and testing of SG adhesives, which is adhered to in most EU states and takes local regulations into account.

CSTB 3488: describes the French SG regulations for adhesives.

In the USA

ASTM C 1184: a comprehensive SG adhesive specification standard.

ASTM C 1401: a guideline for SG applications.

In China

GB 16776-2005: a comprehensive SG adhesive specification standard based on ASTM C 1184.

In countries without their own structural glazing standard, ASTM C 1184 or EOTA ETAG No 002 are usually applicable.

Thermal Insulation Included

The facades are mainly responsible for the energy balance of a building. The excellent thermal insulating effect of bonded double or triple glazed units with coated glass can save much of the energy otherwise consumed for heating or cooling. The air trapped between the bonded panes is a poor heat conductor and therefore forms a good insulating layer between the outdoor and indoor air.

The insulating glazing edge seals are predominantly made of bent aluminium or stainless steel spacers filled with a desiccant, thermoplastic polyisobutylene (PIB) as a primary seal and installation aid, and an elastic sealant as a secondary edge seal. Only high-modulus silicone is approved as a secondary seal in structural glazing facades. Sikasil® IG silicone sealants were specifically developed to meet requirements of insulating glazing and feature special advantages:

UV and weathering resistance

Durability

Material compatibility

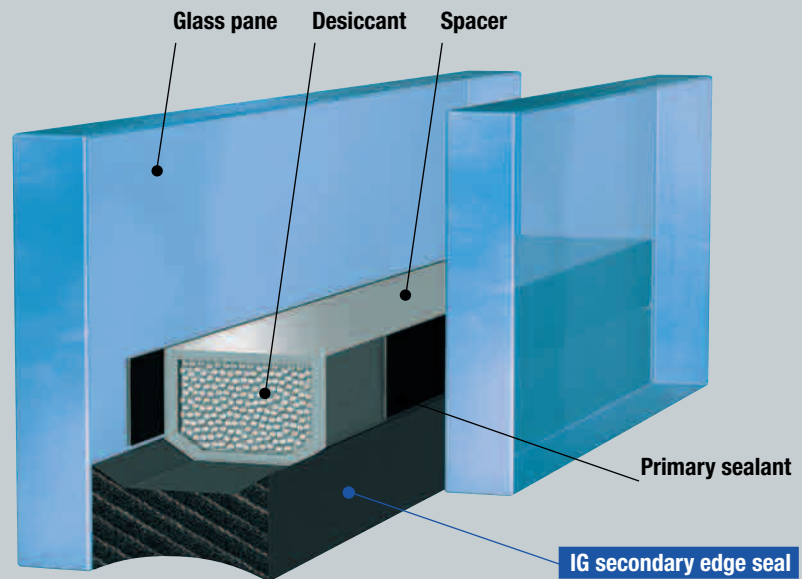

Insulating Glazing – Keeps Energy Costs Low

Integrated Systems

In insulating glazing it is particularly important that no water vapour should penetrate into the space between the panes, since it would condense as water on the cold pane.

To avoid this during the whole service life of an IG unit, use a double-sealed edge seal system:

- Aluminium, stainless steel, or plastic spacers (low thermal conductivity) ensure the necessary distance between panes.
- The desiccant (molecular sieve) absorbs any moisture that penetrates through the edge seal.
- The polyisobutylene primary seal serves as an installation aid, sealing against moisture and minimizing gas leakage in the case of insulating glazing units filled with noble gas (e.g. Argon, Krypton).
- The secondary edge sealant bonds the panes together, provides the double glazing with mechanical stability, and is also a moisture barrier.

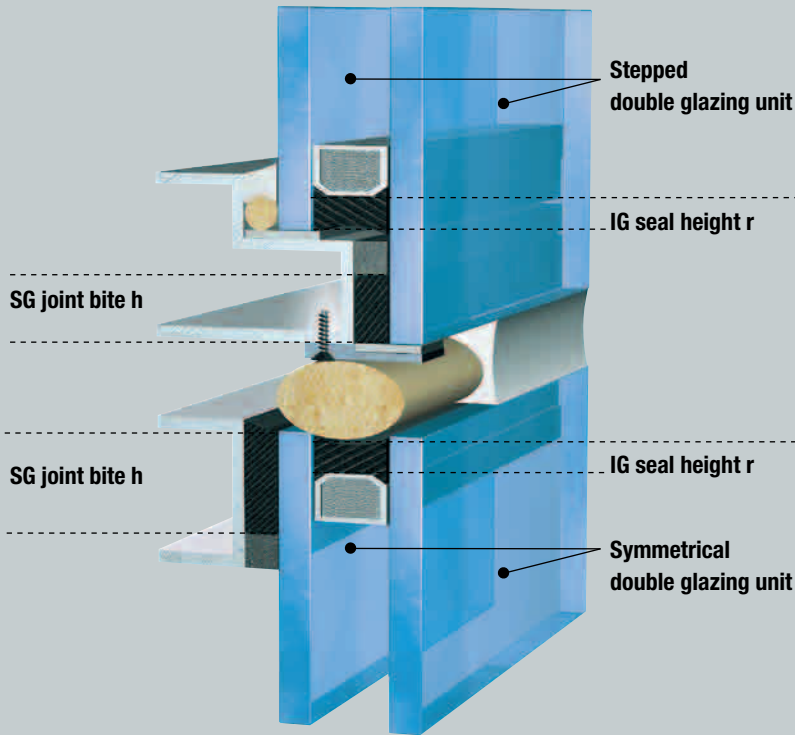

Silicone Seal Height – Detailed Joint Calculation

Calculation of Joint Dimensions in stepped Configurations

The IG seal height r for the inside pane is calculated solely by taking the environmental loads into account when the smaller inside pane is supported by setting blocks. It is advisable to have the seal height checked by one of our FFI Competence Centre. r should be at least 6 mm.

Non-stepped (symmetrical) Double Glazing Units

In the case of double glazing units in mechanically supported structural glazing constructions, the outer glass pane is held onto the frame by means of the secondary edge seal. The minimum seal height r is calculated for two cases A and B (see formulas on the right).

Support from our FFI Competence Centre

For precise and reliable calculations of seal height please contact our FFI Competence Centre.

Important

SG adhesive bonding of an unsupported IG unit is not recommended because of excessively high stress in the IG secondary edge.

If inevitable you should contact FCC Switzerland.

Stepped Double Glazing Unit

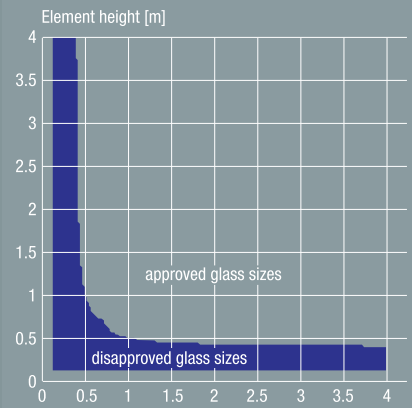

Fig. 1 Only climatic loads are relevant for sealant height calculation

Symmetrical Double Glazing Unit

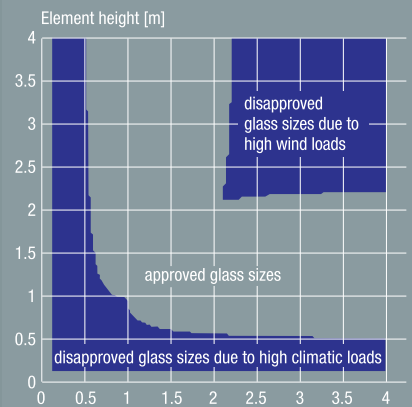

Fig. 2 Climatic and wind load are relevant for sealant height calculation

Simple Calculation of the Seal Height in non-stepped Configurations according to EOTA ETAG 002-2004

A) When the thickness of the outer glass pane $>$ thickness of the inner glass pane:

$$r = \frac{a \times w}{2 \times \sigma_{dyn}}$$

B) When the thickness of the outer glass pane \leq thickness of the inner glass pane:

$$r = \frac{a \times w}{4 \times \sigma_{dyn}}$$

- $r =$ height of the insulating glass secondary seal (mm)
- $a =$ longest of the short glass edges of the project (mm)
- $w =$ maximum wind load to be expected (kN/m²)
- $\sigma_{dyn} =$ permissible adhesive stress for supported constructions;
for **Sikasil® IG-25**: 140 kPa = 0.14 N/mm²
for **Sikasil® IG-25 HM Plus**: 190 kPa = 0.19 N/mm² according ETA



Influence of Glass Thickness on Seal Height

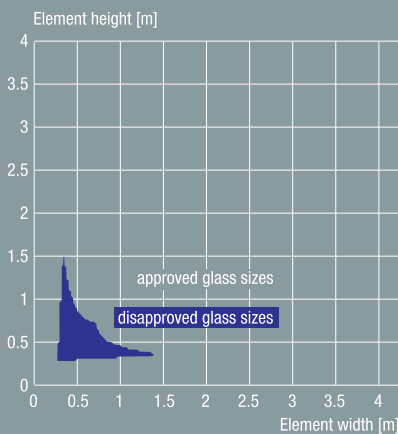
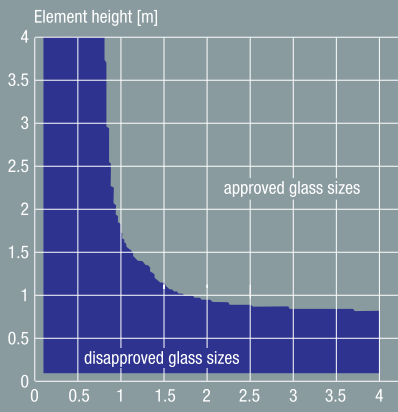
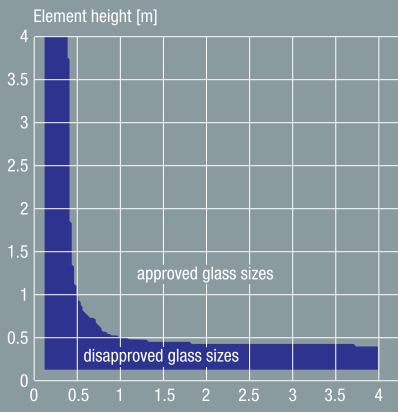
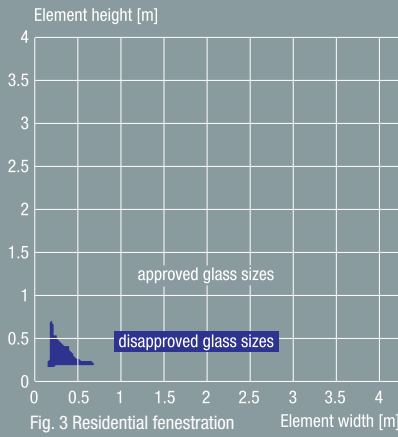
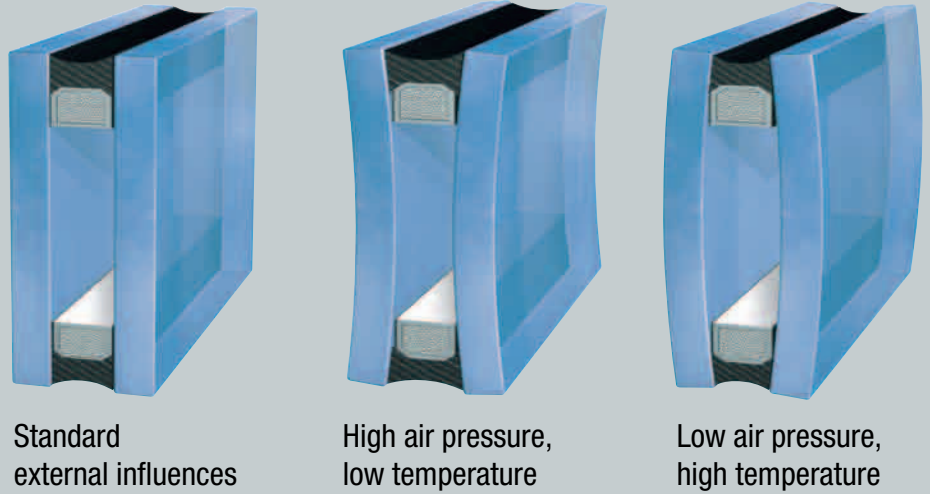

Fig. 7 Glass deflection due to climatic loads



Effect of Environmental Loads on Double Glazing Units

Especially for small glass panes and non-standard formats, for a precise calculation of the IG sealant height there are 4 steps to consider:

1. Calculation of isochoric pressure p_0

The isochoric pressure is a theoretical pressure caused by climatic loads such as max. estimated difference of temperature ΔT and atmospheric pressure Δp_{atm} and the difference in altitude ΔH of production site of the IG unit and its installation site.

An average value for p_0 of 16 kPa has to be considered. For extreme changes of temperature or altitude, p_0 has to be calculated with the formula below.

2. Estimation of Glass Deflection

Based on the value of p_0 the deflection of

the glass panes is calculated by various methods (e.g. Plate method or Timoshenko method). The deflection is influenced by the pane thickness and their size (see Fig. 4 and 5). Small, thick panes require big seal heights (see Fig. 6, e.g. IGU 0.75×0.75 m: minimum seal height of 18 mm).

3. Real internal Pressure

The increase of the cavity volume by the glass deflection reduces the isochoric pressure to the real internal pressure. The pump action caused by environmental loads is shown in the illustrations in Fig 7.

4. Total Load on the secondary Seal

The sum of the climatic load of point 3 and the wind load results in the final load on the IG edge seal (see Fig. 1 and 2).

$$p_0 = (\Delta T \times 0.34 \text{ kPa / K}) + \Delta p_{atm} + (\Delta H \times 0.012 \text{ kPa/m})$$

Product Name	Sikasil® IG-16	Sikasil® IG-25	Sikasil® IG-25 HM Plus
Curing system	neutral silicone	neutral silicone	neutral silicone
Components	one-part	two-part	two-part
Processing	with guns from cartridges or foil packs	machine mixing	machine mixing
Maximum of seal height [mm]	~ 15	~ 50	~ 50
Applications:			
- Standard IG for windows and capped CW systems	X	X	X
- Symmetrical IG for SG		X	X
- Stepped IG for SG	X ³⁾	X	X
- IG in two-sided SG	X	X	X
- IG for bolted curtain walls	X ³⁾	X	X
- Gas-filled IGU	X		X
Skin forming time/pot life (23°C/50% rel. humidity) [min]	~ 25	~ 45	~ 110
Permanently elastic range [°C]	- 40 to +150	- 40 to +150	- 40 to +150
Shore A hardness ¹⁾	~ 45	~ 45	~ 60
Tensile strength ²⁾ [N/mm ²]	~ 0.87	~ 0.90	~ 1.4
Modulus at 100% elongation ²⁾ [N/mm ²]	~ 0.83 (50%)	~ 0.90	~ 1.0 (25%)

1) ISO 868, 2) ISO 8339-A, 3) If the IG secondary seal has a structural function, IG-25 or IG-25 HM Plus has to be used. These figures are intended as a guide and should not be used in preparing specifications. For technical information about the products, please ask for the latest respective data sheets.

Sikasil® IG Secondary Sealants – UV-Resistant and Extremely Durable

Tailored Properties

The sealant is chosen according to the individual requirements of the insulating glazing unit. Sika offers Sikasil® IG silicone sealants for the secondary edge seals of insulating glazing units. These sealants are characterized not only by outstanding tooling and bonding characteristics, but also by unparalleled UV stability. This permits durable constructions with a uniformly high quality of workmanship.

Sikasil® IG-16

- One-part system, for the secondary edge seal
- Neutral curing
- Ready to process
- Outstanding tooling properties
- Excellent weathering and UV resistance
- Suitable for stepped double glazing units in curtain walls

Sikasil® IG-25

- Two-part secondary edge seal
- Can be applied by machine
- Outstanding processing properties (dosing and tooling)
- High mechanical strength
- Structural capabilities
- Excellent weathering and UV resistance
- High resistance to water and moisture
- Suitable for all kinds of curtain wall double glazing units

Applicable Standards

The test requirements laid down in international standards are designed to ensure the insulating glazing unit has a minimum lifetime of 10 years. The climatic test usually includes cyclic conditioning of small double glazing units and subsequent testing of vapour permeability (dew point temperature).

- The most important standards are:
- EN1279, Glass in building – insulating glass units
 - Part 1, generalities, tolerances, system descriptions
 - Part 2, moisture vapour penetration
 - Part 3, inert gas leakage rates
 - Part 4, physical attributes of edge seals
 - Part 5, evaluation of conformity
 - Part 6, factory production control

ASTM E 773, ASTM E 774

EN13022 and EN15434:
Standards for insulating glazing in SG curtain walls.



Sikasil® IG-50

polyurethane

two-part

machine mixing

~ 50

X

X

~ 30

- 40 to +90

~ 50

~ 1.5

~ 0.98



Highlight Towers, Munch, Germany; Murphy / Jahn

Sikasil® IG-25 HM Plus and SikaGlaze® IG-50 – Energy-Saving with Inert Gas Filling

Inert Gas Filling

Beside glass coatings the gap-filling with inert gas is one means of reducing heat losses. With an argon-filled cavity the U-value of an IG unit can be reduced by 0.3 W/m²K. This means an oil saving potential of up to 3 litres per year per square meter of glass facade and even 4 times more energy equivalents for cooling in hot climates. For big glass facades this not only means a high potential of energy saving but also a tremendous reduction of carbon dioxide and hence the greenhouse effect.

The high argon diffusion rate of the silicones has been the obstacle to the use in argon-filled IG units. Bending movements of the glass panes due to changes of temperature and atmospheric pressure (page 21, Fig. 6) and the non-elastic behaviour of PIB (SikaGlaze® IG-5 PIB) cause leakage of the primary seal and thus cause high gas loss rates in IG units sealed with silicone.

With the ultra-high-modulus IG silicone sealant Sikasil® IG-25 HM Plus it is possible to produce Argon-filled IG units complying with the European standard EN1279 part 3 for argon-filled IG units. As the PIB layer in fact is the argon barrier, comprehensive application know-how and quality control during the IG production are crucial. For the stability requested in SG facades these IG units can be produced with rigid box-shaped spacer bars (aluminium or stainless steel). This meant the breakthrough of argon-filled IG units into the structural glazing facades as shown in 2004 in Helmut Jahn's Munich Highlight Towers, glazed with 20000 m² of IG sealed with Sikasil® IG-25 HM Plus.

For gas-filled IGU in capped curtain wall systems and conventional window systems SikaGlaze® IG-50 polyurethane can be used if the edge seal is not exposed to UV radiation.

Sikasil® IG-25 HM Plus

- Two-part silicone secondary edge seal
- Can be applied by machine
- Outstanding processing properties (dosing and tooling)
- Very high mechanical strength
- Very high design factor (0.19 N/mm²) for slim edge sealing
- Excellent weathering and UV resistance
- Extremely high resistance to water and moisture
- Structural capabilities
- Suitable for all kinds of curtain wall insulating glazing units

SikaGlaze® IG-50

- Two-part polyurethane secondary edge seal
- Can be applied by machine
- Outstanding processing properties (dosing and tooling)
- Very high mechanical strength
- High resistance to water and moisture
- Suitable for all kinds of capped curtain wall insulating glazing units

Ask your Sika sales representative for our primary seal SikaGlaze® IG-5 PIB.

Sikasil®	WS-305 CN	WS-605 S
Components	one-part	one-part
Curing system	neutral	neutral
Skin forming time (23 °C/50% rel. humidity) [min]	~ 35	~ 25
Permanently elastic range [°C]	-40 to +150	-40 to +150
Shore A hardness ¹⁾	~ 15	~ 20
Tensile strength ²⁾ [N/mm ²]	~ 0.50	~ 0.45
Modulus at 100% elongation ²⁾ [N/mm ²]	~ 0.30	~ 0.27

1) ISO 868, 2) ISO 8339-A.

These figures are intended as a guide and should not be used in preparing specifications.
For technical information about the products, please ask for the latest respective data sheets.

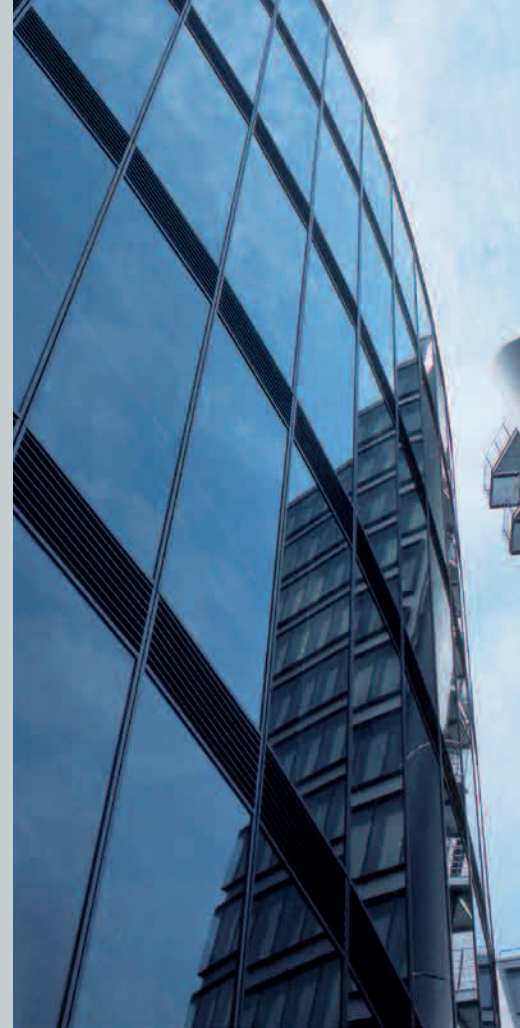

Telecom Centre Munich, Germany; Kiessler + Partner

Sikasil® WS Weatherseals – Effective Protection Against the Elements

Perfect Appearance

The quality and optical appearance of a curtain wall are critically dependent on appropriate weather sealing. The individual elements are ultimately subject to extreme movements due to temperature changes, moisture (in the case of concrete), shrinkage of construction materials (wood, concrete), sound, wind and vibrations, which may affect the joints and adjacent elements.

The joints between the elements may be effectively sealed with preformed gaskets or alternatively with UV and weather resistant silicone sealants. Sikasil® WS silicone sealants preserve the quality and perfect optical appearance of the facade in the long term, thanks to their outstanding advantages:

- UV and weathering resistance
- Improved impermeability to air and driving rain
- Very good movement absorption

Dimensioning of Weatherproofing Joints

In general

- The joint edges must run parallel to a depth of twice the joint width, but at least 30 mm. This gives the backing material sufficient grip
- For most sealants, the joint width must be at least 4 times the expected joint movement, which results from 25% movement capability
- The optimal ratio of joint width to depth is 2:1 (see Fig. top right)

Project-Specific Adhesion Tests

For weather-tight sealing of a curtain wall, it is essential to ensure optimum adhesion of the sealant to the surfaces. Before the sealant is used, it should therefore be individually tested for perfect adhesion to specimens of the project material at Sika's FFI Competence Centre.

Individual Colour Scheme

For weatherseals and natural stone sealants, Sika offers project-specific colour matching services. In addition to the wide range of standard colours, Sika also offers individual special colours on request. Please note that special colours are subject to special delivery conditions such as minimum order quantities and delivery times. Your Sika sales manager will be pleased to give you further details.

- Sikasil® WS-305 CN

- Ready-to-use one-part sealant
- Neutral curing
- UV and weathering resistant
- Highly flexible

- Sikasil® WS-605 S

- Ready-to-use one-part sealant
- Neutral curing
- Non-streaking on glass and metal surfaces
- UV and weathering resistant
- Highly flexible





18

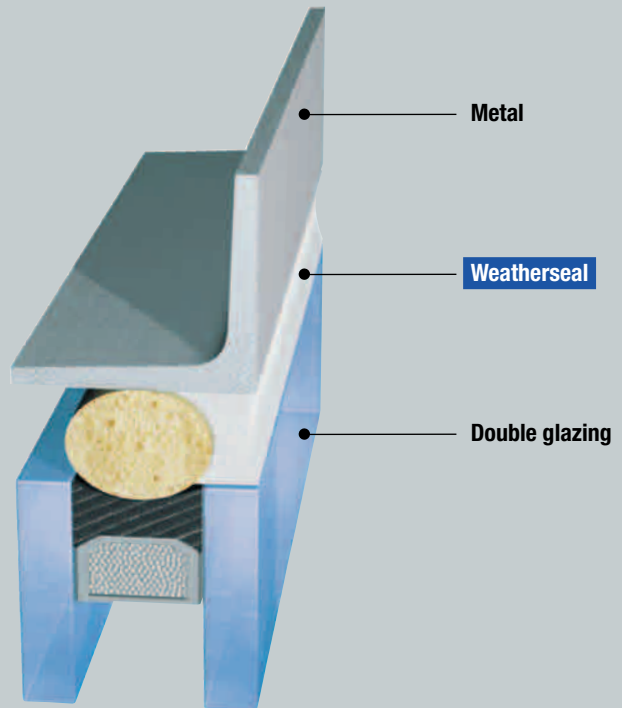

Weatherseal, double glazing/metal, joint width: depth = 2:1

Weathersealing of Bolted Glass Facades

To ensure the correct choice of a sealant in bolted glass facades, Sika recommends checking the design and statics. This is necessary to ascertain whether the sealant only serves as a highly elastic weatherseal or whether it also acts as a structure-stiffening element, in which case it must also be taken into account in the static calculations. On request, our FFI Competence Centre carries out individual calculations and tests for each project.

Did you know?

Sika offers a complete set of Sikasil® SG, IG and WS products including Sika® Spacer Tape HD and the IG butyl SikaGlaze® IG-5 PIB in a harmonised shade of grey. Your Sika sales manager will be pleased to give you further details.

Water/Vapour Proofing Membranes

Connections of the glass facade to the concrete structure can be too wide for wet sealing. For sound water proofing Sika offers sophisticated vapour control membrane systems (see page 30).

Weatherproofing Gaskets

UV-resistant silicone rubber gaskets are suitable for use as structural glazing weatherseals. All gaskets (particularly non-silicones such as EPDM) have to be individually tested for compatibility according to ASTM C 1087 or EOTA ETAG No. 002.

Standards and Guidelines

Because of the requirements for the sealant, standards for weatherseals are significantly different from those for structural glazing applications.

ISO 11600

ISO 11600 is the world's first standard to combine the classification of widely different sealant grades and their tests. However, national standards, such as ASTM C 920 and DIN 18545 are also important, not only because of local practices, but also because of specific characteristics such as the abrasion test (DIN 18545) or early movement capability (DIN 18540).

Sikasil®	WS-355
Components	one-part
Curing system	neutral
Skin forming time (23 °C/50% rel. humidity) [min]	~ 20
Permanently elastic range [°C]	-40 to +150
Shore A hardness ¹⁾	~ 22
Tensile strength ²⁾ [N/mm ²]	~ 0.47
Modulus at 100% elongation ²⁾ [N/mm ²]	~ 0.28

1) ISO 868, 2) ISO 8339-A.

These figures are intended as a guide and should not be used in preparing specifications. For technical information about the products, please ask for the latest respective data sheets.



Gansu Province Finance Bureau, Lanzhou, China

Natural Stone Sealing – Perfect even in Sensitive Areas

Sealants Suitable for Natural Stones

Natural stones such as granite, marble and sandstone are highly sensitive materials when used on facades. Where an inappropriate sealant is used, there may be staining of the joint edges or streaking, which greatly impairs the optical appearance of the facade. Sika therefore recommends special system-compatible Sikasil® WS silicone sealants ideally suited for use with extremely sensitive natural stone elements, or connecting metal facades and curtain walls to natural stone elements.

They contain no volatile compounds that could migrate into the pores of the natural stone. We therefore describe them as non-staining. These non-staining silicone sealants are also recommended for glass facades in order to reduce streaking on glass panes and metal panels and to minimize the need to clean the facade.



Important

Since all natural stones are very sensitive materials, a non-staining test should be carried out at our FFI Competence Centres before any natural stone sealing operation. This is an essential precondition for non-staining warranty.





19

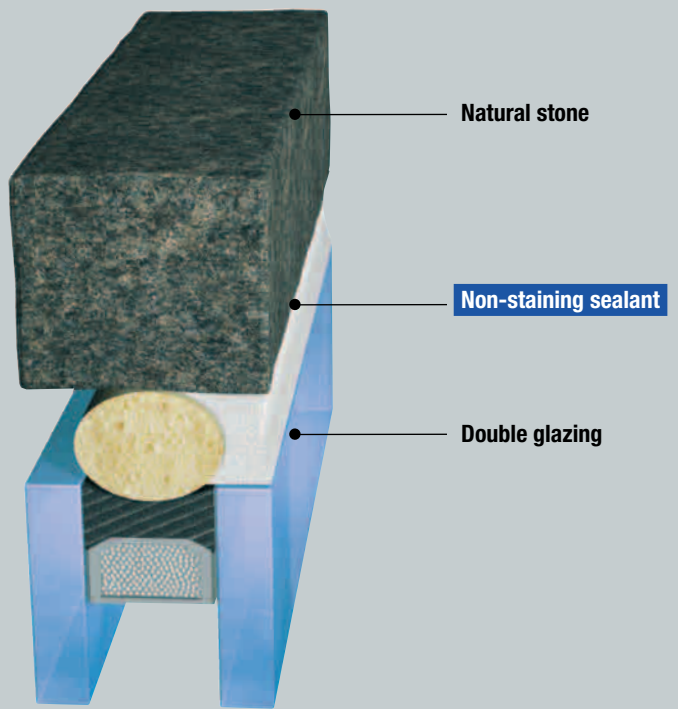

System-Compatible Primers

Use Sika® Primer-210 to ensure long-term adhesion to stones of all types. Exact instructions for applying primer and sealant are given in our application guidelines.

Sikasil® WS-355

- Weatherseal for natural stone facades
- Ready-to-use one-part sealant
- Neutral curing
- No staining on natural stone
- UV and weathering resistant
- Highly flexible

Applicable Standards

The worldwide most frequently quoted standard for non-staining sealants is ASTM C1248: Standard Test Method for Staining of Porous Substrates

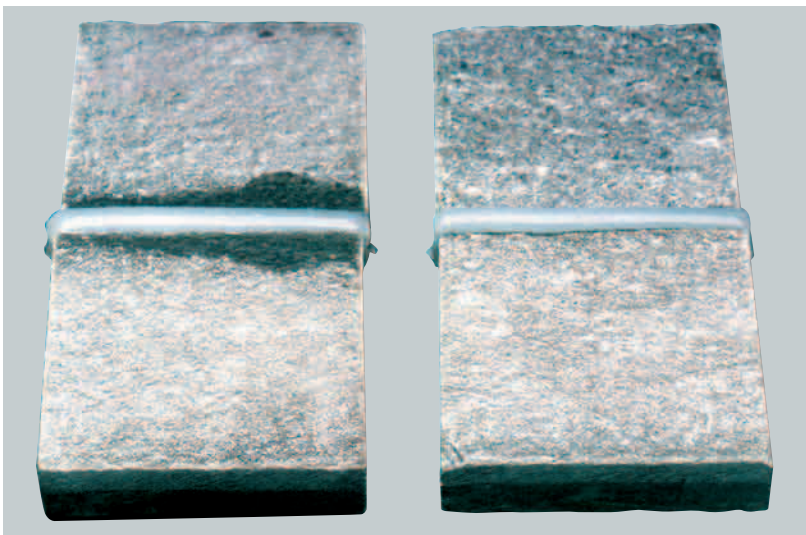

Using the wrong sealants causes staining of natural stone elements (see left specimen).



Isbank Towers Istanbul, Turkey; Swanke Hayden Connell Architects, Tekeli & Sisa

Total Vision Glazing – Perfect Views without Frames

Total Vision Glazing or Fin Glazing is Similar to two-sided Structural Glazing

The glass panes reach from head to sill with tremendous glass sizes. As very high wind loads have to be considered in Asia, where fin glazing is very popular and widely used for glazing of shop fronts and entrance lobbies, the glass panes are stabilized with glass fins. Sika offers a range of products for sealing the joints, due to the variety of glasses used for fin glazing (monolithic, laminated, multipane insulating glass).

Please note that for durable adhesion of silicones the finish of the glass edge (grinding, polishing, etc.) is crucial.

For support in joint design review, joint size calculation and adhesion tests please contact our FFI Competence Centres.

Sikasil® WS-605 S

- Ready-to-use one-part sealant
- Neutral curing
- High flexibility
- UV and weathering resistant
- Available in transparent and other colours
- For laminated and insulating glass

Sikasil® GS-621

- Ready-to-use one-part sealant
- Acidic curing (acetic acid)
- High mechanical strength
- UV and weathering resistant
- Available in transparent and other colours
- For monolithic glass

Sikasil® SG-18, SG-20

- Ready-to-use one-part adhesive sealant
- Neutral curing
- Very high mechanical strength
- Outstanding UV and weathering resistance
- Available in black
- For laminated and insulating glass

Did you know?

With Sika's 2-part polyurethane SikaGlaze® GG the glass panes can be embedded in the floor avoiding any stress concentration and glass cracks. For details browse www.sika.com/ses.



Sikasil®	FS-665	FS-665 SL
Components	one-part	one-part, self-levelling
Curing system	neutral	neutral
Skin forming time (23 °C/50% rel. humidity) [min]	~ 15	~ 50
Permanently elastic range [°C]	-40 to +150	-40 to +150
Shore A hardness ¹⁾	~ 25	~ 15
Tensile strength ²⁾ [N/mm ²]	~ 0.60	~ 0.75
Modulus at 100% elongation ²⁾ [N/mm ²]	~ 0.39	~ 0.32

1) ISO 868, 2) ISO 8339-A.

These figures are intended as a guide and should not be used in preparing specifications.
For technical information about the products, please ask for the latest respective data sheets.



CNOOC Building, Beijing, China; Kohn Pedersen Fox Associates PC

Fire-rated Sealing – Only the Best is Good Enough

Fire-rated Sealing

Many casualties have been reported in serious fire catastrophes, not only because of fire but of smoke poisoning. The integrity of the joints is inevitable and gives fire brigades a chance to rescue people. Sika offers 4 hours fire-rated sealants both for vertical joints in facades and for horizontal floor joints between the facade and the floor slabs.

For fire-rated sealing of indoor joints please ask for Sikacryl® FS-265. It can be overpainted and is 2 hrs fire rated against UL 2079.



Standards and Guidelines

A wide variety of local standards and guidelines have become established worldwide. The most important are:

In Europe

EN 13501, parts 1– 5, Fire classification of construction products and building elements

BS 476, part 20: Fire resistance tests

DIN 4102: flammability classification

In the USA

UL 94: Flammability Tests of Materials

UL 1479: Fire Tests of Through-Penetration Firestops

UL 2079: Tests for Fire Resistance of Building Joint Systems

Sikasil® FS-665

- Weatherseal for fireproof facades
- Ready-to-use one-part sealant
- Neutral curing
- Non-sagging
- UV and weathering resistant
- Highly flexible
- Tested against BS476, part 20: 4 hours fire-rated
- UL Listed, tested against UL2079: 2 hours fire-rated
- Classified DIN 4102, B1

Sikasil® FS-665 SL

- Fire-rated, self-levelling sealant for horizontal joints
- Ready-to-use one-part sealant
- Neutral curing
- Self-levelling
- UV and weathering resistant
- Highly flexible
- Tested against BS476, part 20: 4 hours fire-rated
- Classified DIN 4102, B1

Product Overview

	Standard System		Self-bonding System (2-sided)
SikaMembran®	Outdoor	Universal	FJ-25 SB2
thickness [mm]	0.6	0.6	0.35
μ -value	52000	98000	71000
s_d value [m]	30	60	25
System adhesive	SikaBond® TF-Plus N	SikaBond® TF-Plus N	2 sides self-bonding
Standard widths of 25 m rolls [cm]	10/15/20/25/30/35/40/45/50 higher widths on request	10/15/20/25/30/35/40/45/50 higher widths on request	5.0/7.5/10/15 higher widths on request
Main applications	Connecting joints in concrete and brick constructions in ventilated facades		Capped curtain wall systems

These figures are intended as a guide and should not be used in preparing specifications. For technical information about the products, please ask for the latest respective data sheets.

Vapour Proofing with Membrane Systems

Water Vapour in Buildings

Along with wind-driven rain, water vapour alone can also become a major problem in the structural framework. If the air is cooled to below the dew point, the excess moisture condenses as liquid water within the structure.

A "moisture transport mechanism" of this kind where water migrates through structural members in the form of vapour is particularly apparent in climates like that of Western and Central Europe and other similar climatic regions in the winter months.

There is more water vapour in the atmosphere in heated rooms than there is in the outside air, and their difference in concentration is balanced by vapour diffusion from the inside to the outside. This phenomenon

is obviously reversed in tropical regions with a hot, damp climate outside but with cool, air-conditioned rooms inside.

According to German Standard DIN 4108 "Thermal Insulation in Buildings", a structural element must be designed so that an unacceptable quantity of condensed water is not produced inside the structure; for instance when water vapour diffuses moving from inside to outside and meets a material with a very high vapour diffusion resistance and/or a layer of thermal insulation.

System Solutions

With SikaMembran® system solutions, facades can be protected effectively and fully in line with their requirements, both for curtain walling in glass and for concrete structures.

A secure connection to the structural formwork, yielding durable waterproofing of the joints, is obtained by the quick and easy bonding of the membranes between the envelope fabric and the structure, with the very tolerant and efficient elastic adhesive SikaBond® TF-Plus N.

For comprehensive information please ask for our brochure "**SikaMembran® Systems – Membranes for intelligent Sealing of Facades**"





GLA City Hall, London, UK; Foster & Partners



Adia Building, Abu Dhabi, UAE; Kohn Pedersen Fox Associates PC

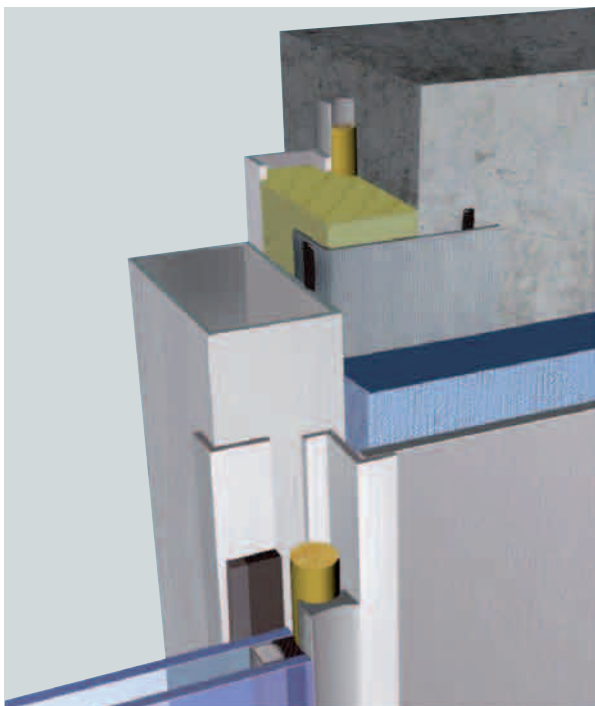

For wide gaps between the curtain wall and concrete structure SikaMembran® is the best solution.

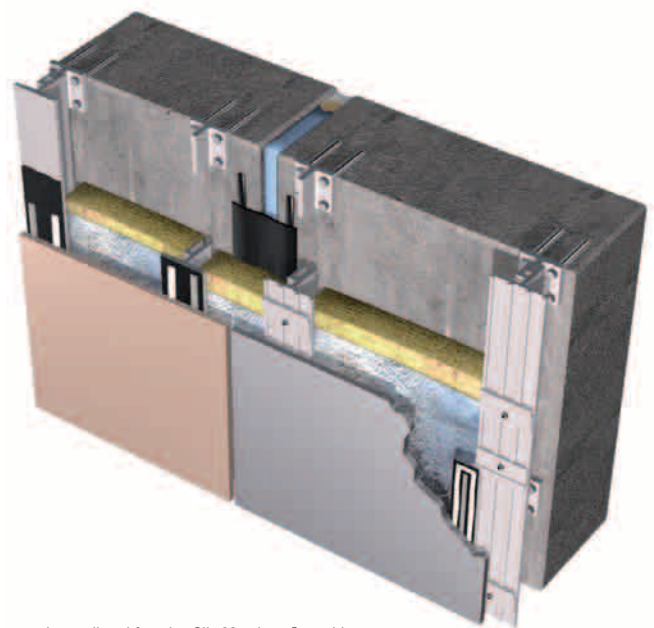

In ventilated facades SikaMembran® provides an adequate vapour barrier throughout the whole year's climatic conditions. Water vapour must not be trapped in the structure.

Surface Treatment Products

Product	Application
Sika® Cleaner P	Cleaner for all types of plastics and powder-coated metals
Sika® Cleaner G & M	Cleaner for highly contaminated glass and anodised aluminium
Sika® Aktivator-205 (Sika® Cleaner-205)	Cleaner/activator for anodized aluminium, stainless steel, and many powder coatings
Sika® Primer-210	Primer for porous vitreous surfaces
Sika® Primer-790	Primer for organic coatings (PVDF, PPC)
Sika® Mixer Cleaner	Cleaner for two-part mixing machine

Important

Sika® Cleaner-205 has been renamed to Sika® Aktivator-205

Sika® Ancillary Products – for Complete Structural Glazing

System-Oriented Execution

Perfect structural glazing execution requires careful coordination of details. Sika therefore offers a wide range of ancillary products for preparing substrates and processing sealants. These auxiliaries integrate into the whole facade product system and are carefully matched to Sikasil® silicone sealants. They will round off your structural glazing job.

Pretreatment for Optimum Adhesion

Thorough cleaning of the glass and metal surfaces is essential for reliable bonding of the Sikasil® SG silicone adhesive sealants. Therefore Sika supplies special products with optimized adhesion to a wide variety of materials. Our FFI Competence Centres will carry out thorough tests on the project materials to determine the best primer to use on the metal frame employed. Based on our experience and the test results, we will make specific product recommendations for each structural glazing project.

Glass does not usually need to be primed where Sikasil® silicone products are used.





Recommendations for Cleaning and Priming common Materials

Surface	Cleaning agent
Float glass ¹⁾	Sika® Cleaner P ²⁾
Pyrolytically coated glass	Sika® Aktivator-205 or Sika® Cleaner P ²⁾
Ceramic-coated (enamelled) glass	Sika® Aktivator-205
Stainless steel	Sika® Aktivator-205
Anodized aluminium ³⁾	Sika® Aktivator-205 or Sika® Cleaner G & M
Polyester powder-coated aluminium	Sika® Aktivator-205 or Sika® Primer-790
PVDF-coated aluminium	Sika® Aktivator-205 or Sika® Primer-790

- 1) Including tempered, toughened, laminated and tinted types
- 2) Sika® Cleaner P only where Sika® Aktivator-205 is not acceptable for aesthetic reasons, for surfaces highly contaminated with oil and grease use Sika® Cleaner G & M
- 3) On good quality anodized aluminium, Sika® Cleaner P or G & M is mostly sufficient, but project-specific testing necessary

Compatible Spacers

Sika® Spacer Tape HD has mechanical properties perfectly adjusted to meet the curtain wall requirements. They provide the essential UV resistance and durability, and are the perfect installation aids for structural glazing elements. The open cell structure of the Sika® Spacer Tape HD is permeable to air humidity and thus increases the speed of vulcanization of one-part Sikasil® SG adhesive sealants. These PU foam tapes have been thoroughly tested for compatibility with all Sikasil® silicone sealants, and a warranty to this effect is provided.

Sika® Spacer Tape HD is available in the standard thicknesses of 4.8, 6.4, 8.0 and 9.5 mm.

Sika® Spacer Tape HD is also available in a shade of grey which matches perfectly the grey tone of Sikasil® SG, IG, WS and even SikaGlaze® IG-5 PIB.

Standards

Compatibility tests for sealants with accessory materials are specified in ASTM C 1087 and EOTA ETAG No. 002.

Note: Technical information about the products can be found in the data sheets that can be obtained on request from our sales offices or from our homepage www.sika.com/ses.





Project Service – Individual Consultation and Support

FFI Competence Centres

R&D has always taken pride of place at Sika. At our FFI Competence Centres we combine R&D with a very special service: individualized structural glazing project service and support. This project service is Sika's response to increasing distinctiveness of the buildings and facade projects. Innovative uses of new silicone sealants for facades and windows are in demand; but there is also a growing need for technical support in project planning and execution. At our FFI Competence Centres we develop new products and processing technologies, test known structural glazing methods, and use the results to optimize our technical service and project service. The specialists at our FFI Competence Centres provide

project service and support for structural glazing projects on all continents – from planning through to execution. We place great importance on interdisciplinary cooperation with our partners in the glass industry and with curtain wall manufacturers.

Our Service

- Individualized technical service and support with new designs
- Complete structural glazing system tests including joint design, joint dimensioning, adhesion and compatibility tests with original materials
- Support with performing external tests
- Applicator training at the FFI Competence Centres and in the factory:
Production of double glazing units with silicone secondary edge seals, structural bonding with silicone

- Practical assistance with all processing problems on site by specially trained engineers
- Development of complete ready-to-install solutions for integrated structural glazing systems and difficult processing conditions
- Development of new products in association with the customer
- After testing and approval of the project, warranty for the adhesion of Sikasil® silicone sealants

Sika FFI Competence Centres

- FCC Switzerland
- FCC Dubai

*) FFI stands for Facade, Fenestration, Insulating Glass



Recommended Quality Controls during Structural Bonding

Sikasil® SG-18, SG-20	Sikasil® SG-500, SG-500 CN, SG-550
Skin forming time	Visual control of the mixing quality (butterfly test or marble test)
Tack-free time	Quantitative check of the mixing ratio by weight
Adhesion test on original materials (glass, support frame)	Pot life, Tack-free time
Measurement of Shore A hardness	Adhesion test on original materials (glass, support frame)
Mechanical properties on H-test specimens according to ISO 8339	Measurement of Shore A hardness
	Mechanical properties on H test specimens according to ISO 8339

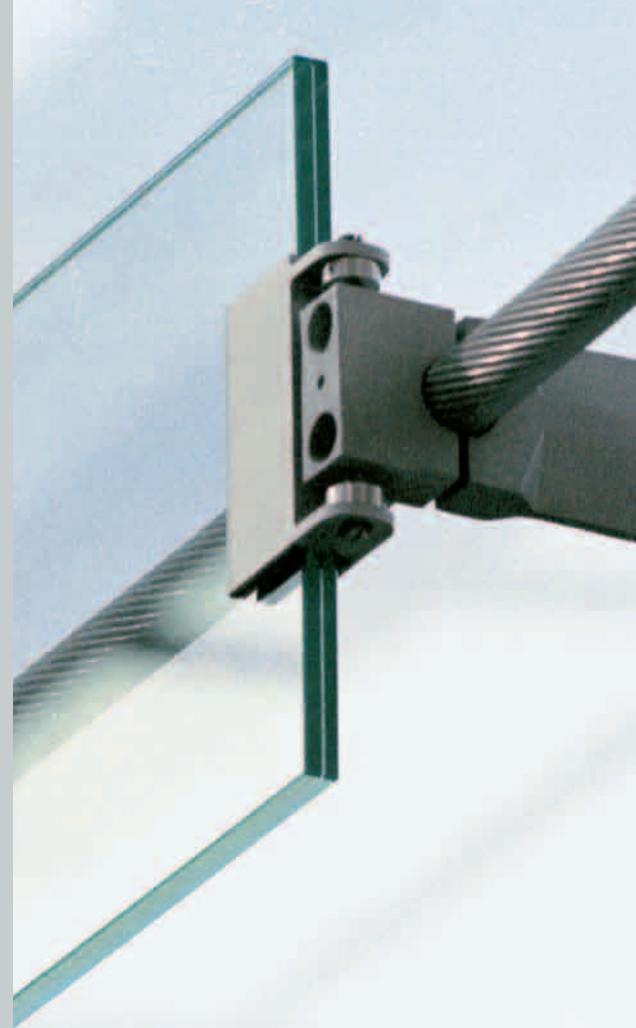

Triple-tested Quality

Systematic Project Workflow

Each structural glazing project is individually tested and approved at our FFI[®] Competence Centre in Switzerland. The customer usually receives design approval and information for joint dimensioning within three working days and the lab report within the time listed in the table on page 36. Work can then begin on bonding the elements. Sika gives a warranty on tested and approved projects.

1. Sealant Tests According to Standards and Guidelines

Silicone adhesives used for structural glazing must withstand extreme demands on their load-bearing capacity and durability. Sika offers one- and two-part systems that conform to the European guideline for bonded glass structures (EOTA ETAG No. 002). The specified tests include, for example, UV/water immersion at 45 °C for 1000 h and exposure to NaCl/moisture and SO₂/moisture. They also comply with American standards ASTM C 920 and C 1135, and Chinese standard GB 16776.

2. Quality Control in Silicone Sealant Production

As a company certified to ISO 9001 and ISO 14001, Sika has developed a quality control system that identifies any deficiencies at the production stage, and guarantees that only perfect goods leave the plant. As a prerequisite for the CE marking Sika's facade silicone production is regularly supervised by external auditing institutions.

3. Quality Control in Sealant Application

For every project, it is essential that the customer should carry out factory production controls, with evidence of the mechanical strength and adhesion to various substrates (see table above). Precise details on the tests can be found in our guidelines for structural glazing application. Sika service laboratories advise customers as to how to perform best these controls and train staff. Of course the test specimens can also be sent to our FFI Competence Centre for testing and approval. All test specimens must be kept for the full warranty term.

Important

Sikasil® SG adhesives should only be used for structural projects if Sika has first given written approval for the particular project.

Duration of Adhesion and Compatibility Tests

	Duration of Tests, incl. Report
One-part Adhesive Sealants Sikasil® SG-18, SG-20	
Adhesion tests with sealant bead	33 days
UV/water immersion test with H-test specimens	55 days
Compatibility test	33 days
Two-part Adhesive Sealants Sikasil® SG-500, SG-500 CN, SG-550	
Adhesion tests with sealant bead	33 days
UV/water immersion test with H-test specimens	33 days
Compatibility test	33 days
All Weather Sealants	
Adhesion tests with sealant bead	33 days
Compatibility test	33 days
Non-staining Sealant Sikasil® WS-355	
Non-staining test	45 days

Project Tests – Safety Down to the Last Detail

Checking Design Drawings

Our FCC check joint design and dimensions. This ensures that the anticipated wind loads and different thermal expansions of the substrates are not outside the stressing limits for our silicone adhesives.

We subsequently provide technical service in the selection of appropriate silicone sealants for structural glazing, insulating glazing and weatherseals.

Adhesion and Compatibility Tests

Adhesion tests according to national and international guidelines and standards, and our own test methods ensure perfect adhesion of our products to the substrates used in any one project. We also test the compatibility of all materials that come

into contact with Sikasil® SG silicone adhesives. Only compatible materials ensure that there is no negative effect on either the adhesion behaviour or the mechanical properties of the silicone adhesives. The results are provided as a report. We use the results obtained to make recommendations on surface treatment, e.g. cleaning and priming, of the substrates used.

Technical Customer Support

The quality and optical appearance of facades also depend on professional workmanship. We therefore advise our project partners to use Sikasil® SG silicone adhesives and sealants. We will demonstrate how to use them professionally, and help with any practical problems.



	Action	Form	Performed by
Design Phase			
Step 1	Project manager (customer) or responsible Sika persons send all relevant design details (drawings - including bonding situation) and project details (wind loads, max. temperatures, glass/panel sizes) to Sika (ch-fcc@ch.sika.com or Fax +41 58 436 5407) for inspection	Project information	Customer
Step 2	Sika - checks joint details - checks joint dimensions - assesses the materials used - recommends the correct sealant for these applications based on all the details known	Design assessment	Sika
Test Phase			
Step 3	Project manager sends all substrates and ancillary materials to Sika for testing. The number and sizes of the samples are described in the leaflet "Project Submittal Information"	Project tests "curtain walls"	Customer
Step 4	Sika conducts the following tests: - Adhesion tests to all substrates (glass, facade panels and frame materials) - Testing compatibility with all materials that our adhesives and sealants come into contact with - Based on the results, Sika makes recommendations for cleaning and, if necessary, priming the surfaces. The results and recommendations are summarized in a laboratory report. A guarantee can only be given if all submitted samples are compatible and the adhesion is sufficient	Lab report	Sika
Application Phase			
Step 5	Sika instructs the applicator on all matters of the applications: - Adhesive application - Quality control during application - Help with machine application Sika also helps with the correct application of its products (e.g. weathersealing) on site. After successful instruction, the customer receives a training certificate from Sika		Sika
Step 6	The customer applies the Sika products as instructed and diligently carries out the recommended quality controls during processing. The quality control is documented on the appropriate Sika forms. If desired and agreed, the customer sends the test specimens to Sika. Mechanical properties are measured in one of the FFI Competence Centres	Quality control	Customer
Warranty Phase			
Step 7	Once application of the products is complete, the customer sends all documents to Sika for inspection		Customer
Step 8	Sika provides a limited guarantee on Sikasil® silicones. For details please ask the local Sika sales manager	Templates are available on request	Sika

Detailed Project Stages

Individual project testing is carried out according to a reliable and practicable system, which forms a solid basis for successful project execution.

Note: Detailed information and descriptions of the practical activities, such as cleaning and priming the surfaces or applying the sealants, can be found in the "structural glazing application guidelines". The forms used for the various stages are available from our homepage www.sika.com/ses.

Properties and Application Characteristics of One- and Two-Part Sikasil® Silicone Sealants

One-Part Systems	Two-Part System
Ready-to-use grade. Already contains cross-linker and catalyst	Basic compound and cross-linker are mixed during application
Supplied in cartridges or foil packs, can be used immediately	Supplied in drums and pails, components must be mixed by machine
Easy to use ("field glazing in two-sided structural glazing, repair glazing, weatherseals)	Execution under controlled conditions in the factory resulting in higher quality of the bond
Require atmospheric moisture for vulcanization at room temperature	No atmospheric moisture required for vulcanization
Vulcanization starts at the surface and continues inwards relatively slowly	Once the components are mixed, curing begins uniformly through-out the joint with a gradual increase in viscosity
Curing rate depends on relative air humidity, temperature and joint depth (see graphics)	Curing rate depends virtually only on the temperature
Minimum time span between bonding and assembly of the structural glazing elements: 2 to 4 weeks depending on air humidity and joint dimensions	Minimum time span between bonding and assembly of the structural glazing elements: 3 to 5 days, depending on frame materials
Joint bite limited to maximum 15 mm, otherwise curing takes too long and there is a risk of cracking	Should be used for thicker silicone adhesive sealant layers Greater joint bite than 15 mm possible, since considerably higher curing rate and lower volume shrinkage on curing
	Efficient factory prefabrication of structural glazing elements possible. Elements are faster to transport and install

Sikasil® Silicone Sealants in Detail – Technical Glossary

Tailored Sealant Systems for all Applications

Sealants are classified according to their curing mechanism into acidic (which emit acetic acid on curing) and neutral systems (which emit oxime or alcohol on curing). For facades, solvent-free, non-corrosive neutral technology is used almost exclusively. The exceptions are all-glass structures, which can also be sealed with acetic-curing sealants.

Typical Properties of Neutral Sealants

- A wide range of adhesion properties for a variety of applications
- Outstanding adhesion and bonding power to glass and metal surfaces
- Early load-bearing, thanks to high initial elasticity
- Reliable and non-corrosive to sensitive materials when used in movement joints, expansion, construction and connection joints
- Application-specific curing time with different vulcanization rates and optimum curing
- Uniform long-term elasticity
- Good elastic recovery
- Durable and extremely strong
- Outstanding weathering and ageing resistance
- Extremely good UV and oxidation stability
- Good chemical resistance and non-yellowing

- Resistant and flexible even with extreme temperature fluctuations from -50 °C to +150 °C
- Low shrinkage in vulcanization
- Long-term resistance to continuous rainfall

Sealant Composition

- Sikasil® silicone sealants generally consist of the following components:
- Silicone polymer
 - Silicone plasticizer
 - Silicone cross-linker
 - Silicone adhesion promoter
 - Reinforcing fillers (e.g. fumed silica)
 - Possibly non-reinforcing fillers, such as silicates, chalks, etc.
 - Optionally, additives such as emulsifiers, pigments and fungicides



Terminology

Elastomer

Generic term for synthetic and natural polymers with rubber-elastic properties

Atmospheric Humidity

In general: the relative humidity (invisible water vapour in the air) that plays an important role in the vulcanization of one-part silicone sealants

Polymer

Substance in which one or more types of molecule are linked together

Polymerization

Chemical reaction in which small molecules link up to form molecular chains (polymers)

Cross-linking

Three-dimensional interlinking of polymer chains to form a polymer network. It is the reason why silicone sealants harden

Vulcanization

Method for converting rubber from a predominantly plastic (pasty) state into an elastic state by cross-linking. The bridges to adjacent molecules are formed by means of vulcanization agents (cross-linkers)

Fungicide

Chemical compound that inhibits microbial growth



Neutral silicones are used for structural glazing ...

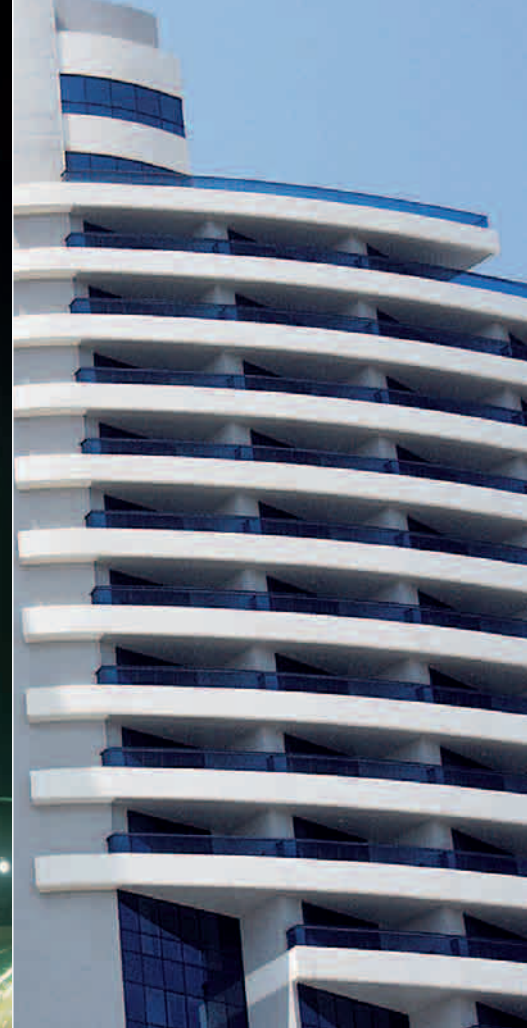

... and are also ideally suited for weatherproof joint sealing

Curing Rate of Sikasil® Silicone Sealants

Curing characteristic of one-part silicones

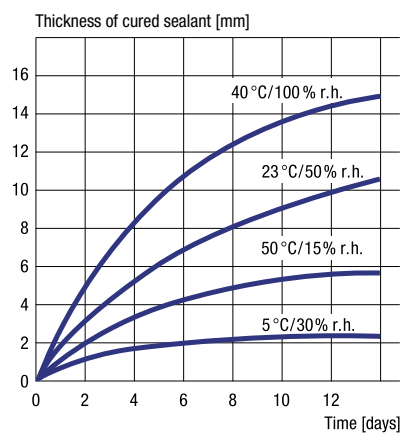

Curing rate of one-part silicones such as Sikasil® SG-20 or Sikasil® WS-605 S

Curing characteristic of two-part silicones

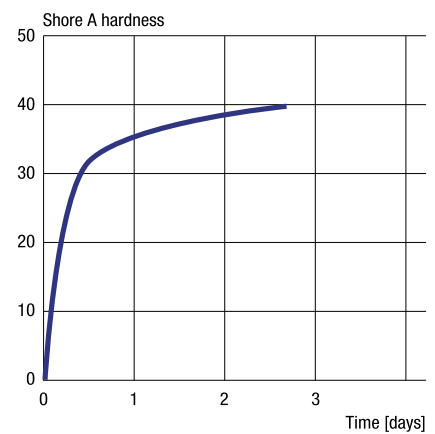

Shore A hardness in the vulcanization of two-part silicones, such as Sikasil® SG-500 or Sikasil® IG-25, as a function of time



Glass Cube; Gehringswalde, Germany

Mechanical Properties

Sealants are classified (e.g. according to ISO 11600) by their mechanical properties.

Tensile Stress or Modulus

This is the quotient of the tensile force measured at a particular elongation and the initial cross-section of the test specimen. For classification as a low-modulus sealant according to ISO 11600 (e.g. ISO 11600 25 LM), this must have a modulus of less than 0.45 N/mm² at 20 °C according to ISO 8339.

Important: In comparisons of data, the shapes of the test specimens are important. Measurements with dumbbell specimens according to DIN 53504 and ASTM D 412 give much higher values than those on H-test specimens according

to ISO 8339 or ASTM C1135, which are more similar to actual joint geometries and are therefore usually used for structural glazing tests.

Tensile Strength

This is the quotient of the maximum measured force and the initial cross section of the test specimen.

Elongation at Break

This is the quotient of the change in length measured at the instant of tearing and the initial measured length of the test specimen.

Shore A Hardness

This is the penetration hardness of polymers. It depends on the modulus of elasticity and the viscoelastic properties of the material. Higher Shore A values ensure a harder material. High-modulus structural glazing silicone sealants usually have Shore A values of over 30. The values for weatherseals are usually between 15 and 25.

Movement Capability

The movement capability is the total elongation and compression that a joint sealant undergoes during service. In the case of silicone sealants according to ISO 11600, it is between 20 and 25% of the initial width. According to ISO 9047, classification 25 is based on elongation and compression cycles with an amplitude of $\pm 25\%$.

Adhesion

Silicone sealants adhere very well to many substrates. The adhesion depends on the type of material to be bonded, the stresses, the type of adhesive bond and surface treatment. The surfaces must be absolutely clean and grease-free. Before the start of sealant application on any construction projection, always carry out adhesion tests on the surfaces in question.



Some relevant Internet Links:

www.aia.org

www.archinform.de

www.architecture.com

www.architectureweek.com

www.emporis.com

www.eota.be

www.glassfiles.com

www.riba.com

www.uia-architectes.org

Terminology

Adhesion

Tendency of a solid surface to stick to a second phase, which may be a liquid or a solid film

Adhesion Loss

Undesirable separation of the adhesion bond, e. g. separation of a joint

Adhesion Value

Force between an adhesive bond, or the force necessary to separate the bond

Cohesion

The integrity of substances as a result of chemical bonding or physical intermolecular forces

Cohesive Fracture

Undesirable material fracture, e. g. in the joint



IFLEX Park, Bangalore, India

Weathering and Ageing Resistance

Silicone sealants have better weathering and ageing resistance than other joint sealants. Their physical properties do not change, even after years of outdoor weathering.

Compatibility with Coating Materials

Silicone sealants are usually compatible with coating materials (powder paints, liquid paints and varnishes) on the construction materials, but this should always be tested. However, standard silicone sealants cannot be painted with liquid coating material (paints or varnishes). Streaking and running usually occurs during application.

Important: Most of the coating materials used in building construction and in almost all window constructions are less elastic than sealants. A continuous coating may

therefore tear if the dimensional change of the sealant is greater than the elasticity of the coating. Elastic sealants in settlement joints must therefore never be completely coated. Only sealants subject to low movements up to approx. 5% can be coated completely. Sealants coming into contact with coatings must be compatible with them (in conformity with DIN 52452 part 4).

Chemical Resistance

Vulcanized silicone sealants have good resistance to weak acids and alkalis, polar solvents and salt solutions. Silicone sealant swells to a greater or lesser extent in solvents such as ketones, esters, ethers, aliphatic, aromatic and chlorinated hydrocarbons. It is restored to its original shape after evaporation of the solvents.



High and Low Temperature Behaviour

The stress/strain value (modulus) of silicone sealants – unlike organic sealants – remains practically constant over a wide temperature range from -30 to $+80$ °C. The tensile strength increases at low temperatures. Silicone sealants are thus ideal for compensating for joint expansions occurring as construction elements cool to low temperatures. The tensile stresses in the joint flanks are not increased, and there is reduced risk of loss of adhesion and consequent adhesive fracture. Below -50 °C, there is partial crystallization of the silicone elastomers and the sealant hardens. At -123 °C (the glass transition temperature) embrittlement occurs.

Silicone sealants are extremely heat resistant. In dry air up to $+150$ °C, all grades retain virtually their full elasticity. Special silicone sealant grades are even heat resistant up to $+250$ °C. It is important that silicone elastomer should be fully vulcanized before it is subjected to high temperatures, and that the curing by-product has evaporated completely. Heat resistance can be further enhanced by subsequent annealing at slowly increasing temperature and with good ventilation.

Shelf Life

If stored in the original sealed containers at temperatures below 25 °C, silicone sealants have a shelf life of at least 12 months, and some grades at least 18 months.

Basic Rules

Low-modulus silicone sealants must not be used for structural glazing bonding

Acetoxy-curing silicone sealants are incompatible with alkaline substrates such as mortar and concrete, and with corrosion-sensitive metals such as lead, zinc, copper, brass and ferrous metals

Fungicide-containing sealants must not be used for the production of aquaria

Standard silicone sealants must not be used for sealing settlement joints and expansion joints between porous natural stone (e.g. granite, marble, sandstone, etc.). There is a risk of staining.

Standard silicone sealants can cause environmental stress cracking in contact with pre-stressed acrylic and polycarbonate construction elements

Silicone sealants do not adhere to polyethylene and polytetrafluoroethylene

Contact with organic elastomers (such as EPDM and Neoprene) can not only cause discoloration of the sealant but can also reduce its mechanical strength and cause adhesive failure

Special Solutions – Restrictions on Use

Please note the incompatibilities mentioned here. Sika has developed special products to cover most problems. Further information is provided in the data sheets. We will be pleased to advise you on any type of application problem and find a solution.





Extension of State Department, Berlin, Germany; design of glass facade: James Carpenter Design Associates

Gas and Water Vapour Permeability

At room temperature, the gas permeability of silicone sealants is about ten times higher than that of natural rubber. At 100 °C to 150 °C, the permeability values are approximately the same. The water vapour permeability according to DIN 53122, climate D, film thickness 2 mm, is approx. $20 \text{ gm}^2\text{d}^{-1}$.

Coefficient of Expansion

The coefficient of cubic expansion of silicone sealants depends on the nature and the amount of fillers used. It is in the range $4 \times 10^{-4} \text{ K}^{-1}$ and $8 \times 10^{-4} \text{ K}^{-1}$. The coefficient of linear expansion is approximately a third of the cubic expansion, i. e. from $1 \times 10^{-4} \text{ K}^{-1}$ to $3 \times 10^{-4} \text{ K}^{-1}$.

Thermal Conductivity

The thermal conductivity of silicone sealants depends on the nature and the amount of fillers used. It is in the range from 0.15 to $0.25 \text{ W K}^{-1}\text{m}^{-1}$ at room temperature (DIN 52612).

Physiological Characteristics

All silicone sealants emit by-products on curing. They may be acetic acid, alcohols or oximes, depending on the sealant grade. We therefore advise users to read the data sheet and safety data sheet in advance. In general, they should be applied in a well-ventilated room. Vulcanized silicone sealants are non-toxic. Special grades are available for contact with foods and drinking water.

Microbial Resistance

Unlike organic sealants, silicone sealants are not attacked or degraded by microbes (bacteria or fungi). However, microbes can accumulate on the surface of dirty silicone sealants, particularly in warm and moist conditions occurring in bathrooms and kitchens. This causes discoloured patches on the sealant surface without its mechanical properties changing. For warm and moist applications, therefore, a fungicide-containing sealant should be used.

Sika Worldwide



Sika is a globally active company supplying the specialty chemicals markets. It is a leader in processing materials used in sealing, bonding, damping, reinforcing and protecting load-bearing structures in construction (buildings and infrastructure construction) and in industry (vehicle, building component and equipment production).

Sika's product lines feature high-quality concrete admixtures, specialty mortars, sealants and adhesives, damping and reinforcing materials, structural strengthening systems, industrial flooring and membranes. Subsidiaries in more than 74 countries worldwide and approximately 13,500 employees link customers directly to Sika.

Technical Service

Sika Services AG
FFI Competence Centre
Tüffenwies 16
CH-8048 Zürich
Phone +41 58 436 5287
Fax +41 58 436 5407
ch-fcc@ch.sika.com

Customer Service

Sika Engineering Silicones Srl.
Via L. Einaudi, 6
I-20068 Peschiera Borromeo (MI)
Phone +39 02 516591 205
Fax +39 02 516591 298
it-ses-admin@it.sika.com



Facades by (Project No.) Josef Gartner GmbH, (Front, 3, 5, 13, 14, 18, 21, 27); Schmidlin AG (1, 2, 17, 22, 23); Yuanda (6, 8, 19); Cuhadaroglu (11, 20, 26); Mero (4, 25); Alico (7); Compact Metal (9); Inasus (12); Vitro Cristalglass (16); **Photos by:** Gardin & Mazzoli (14, 18); Daniele Domenicali (Front, 3); Guy Nowell (13); Beyond Architecture Cultureal Development Co Ltd, Mr. Zhou Li (21)

Our most current General Sales Conditions shall apply. Please consult the most current local Product Data Sheet prior to any use.



www.sika.com/ses

Innovation & Consistency | since 1910