



# Sika Solutions for Sealing of Floor, Pavement and Other Specialty Joints



Innovation & Consistency | since 1910



# Sika Solutions for Sealing of Floor, Pavement and Other Specialty Joints

Joint sealants make up only a small portion of the monetary value of a construction project and are often considered as an unimportant detail. Yet, joint sealants play the major role in keeping a building air and water tight and thus prevent damages with unforeseeable consequential costs.

In order for a sealant to fulfil its function over the whole lifetime of a building or construction the selection of the right solution and the correct design taking into account all potential influences are essential. Especially horizontal expansions joints in floors, decks and roadways have to withstand high mechanical forces and aggressive chemical influences. In this brochure Sika solutions and concepts for floor and pavement joint sealing as well as other special applications are described in detail.

## Content

Elastic Sealing Solutions for Joints and their Requirements	4
Sealing Solutions for Joints in Industrial Floors	6
Sealing Solutions for Joints in Cleanrooms	8
Sealing Solutions for Floor Joints in Pedestrian Areas	9
Sealing Solutions for Joints in Car Parks	10
Sealing Solutions for Floor Joints in Industrial Kitchens	12
Sealing Solutions for Floor Joints on Balconies	13
Sealing Solutions for Specialty Joints in Containment Bunds and Petrol Stations	14
Sealing Solutions for Specialty Joints in Sewage Treatment Plants	15
Sealing Solutions for Specialty Joints in Airfields, Taxiways and Aprons	16
Sealing Solutions for Joints in Concrete Pavements	17
Sealing Solutions for Specialty Joints for Silos and Tanks in Biogas Plants	18
Further Sika Solutions for Joints and Connections	19
More Construction Details	20
Surface Pre-Treatment Products for Sealants	21
Joint Design Principles and Specification	22
Standards & Approvals	23
Application Matrix	24
Sikadur-Combiflex® SG System	25
Solutions for Joint Renewal and Repair	26
Sika Sealing Solutions Contribute to a Sustainable Future	27



# Elastic Sealing Solutions for Joints and their Requirements

## Introduction

Joints can be found in different parts of a construction, e. g. between concrete slabs, at the connection between floors and walls, in storage tanks, in containment bunds, etc..

Floor joint sealants, but particularly specialty joint sealants have to meet various requirements depending on the function and location of the respective joint. Generally, such a sealant must withstand much higher mechanical and chemical influences than a façade sealant.

The purpose of joint sealing generally is to:

- Prevent passage of media (air, water, chemicals, smoke etc.)
- Provide sound insulation (connection joints between floor and wall)
- Enhance the visual appearance of the whole construction

## Why Elastic Sealing?

Building and civil engineering structures consist of individual elements which exhibit relative movements to each other. The two kinds of movements are the thermal and the structural movement. Temperature differences result in an expansion or contraction of the building elements, i.e. joints become larger (extension) or smaller (compression) continuously. Structural movements often result in shear stress acting on the sealant due to settlements of the structure, vibrations or other loads.

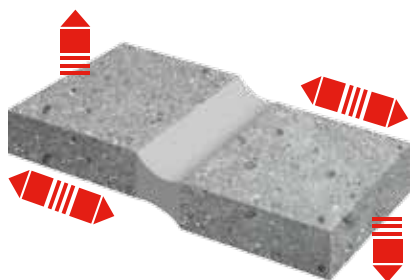

Contraction, Expansion or Shear Load of Building Elements

## Applications and Requirements for Floor, Pavements and Specialty Joint Sealants

Typical application fields for above mentioned types of sealants are the following:

- Manufacturing industry (light, heavy, semiconductor, food, etc.)
- Parking decks
- Pedestrian areas
- Special Applications (filling stations, airfields, containment bunds, waste water treatments plants, etc.)

Requirements for sealants vary significantly from project to project depending on the specific application and exposure level.

Sika offers joint sealing solutions that meet the specific needs of each individual construction project. Our sealants and accessory products are generally designed to ultimately save money for the owner of a building or civil engineering structure: they can be easily and error-free installed, they last very long without decreasing performance and they require none or very low maintenance efforts.

The development of our solutions is based on the latest technologies as well as Sika's more than 100 years of experience in the construction industry.



## Comprehensive Solutions for Joint Sealing by Sika

Sika provides a full range of elastic joint sealants and accessories for buildings and civil engineering structures with the following main advantages:

- Movement capability exactly matching the requirements for a specific joint to ensure long-term functionality
- Perfect adhesion to common construction materials to make sure that the joint remains tight at all times
- Ease of use to minimize installation errors and ensure on-time project completion
- Optimised visual appearance that meets the demands of architects and owners
- High mechanical strength, chemical resistance and weatherability to ensure excellent performance even under most adverse conditions and loads
- Unsurpassed and proven durability that guarantees longevity

With more than 60 years experience in sealants and sealant applications, references on all continents and in all climates Sika's product portfolio is designed to fit all requirements reaching from high movement capability to superior UV and chemical resistance.

Specific **Sikaflex**<sup>®</sup>, **Sikasil**<sup>®</sup>, **Sikacryl**<sup>®</sup> and other brand sealants are designed for a great variety of applications.

In fact, Sika invented one-component elastic polyurethane sealants and the nowadays very popular and waste-reducing foil packaging for sealants. The range of products comprises not only general purpose construction sealants but also virtually "tailor-made" solutions for specific applications such as joints in water and sewage treatment plants where maximum resistance to aggressive chemicals and microorganisms is mandatory.

As market leader in construction chemicals Sika offers comprehensive and compatible solutions for all types of building and civil engineering structures (from "roof to basement") including high-performance sealants. This full range approach ensures reliable and long lasting technical solutions for a long life expectancy of the building or structure.

# Sealing Solutions for Joints in Industrial Floors



## General Description & Main Requirements

Sealants used for floor joints are required to have:

- High mechanical strength
- High abrasion resistance
- Good chemical resistance
- Excellent adhesion properties

Depending on the area of application special requirements are important in addition. The manufacturing industry and the foodstuff industry have a plurality of such additional demands.

Generally, they need sealants which:

- Can withstand traffic loads from fork lifts and cleaning machines
- Are cleanable with high pressure
- Survive the contact with aggressive cleaning agents and other chemicals
- Are compatible with foodstuff

## Sika Solution

### Sikaflex® Floor

- 1-component non-sag sealant
- High mechanical resistance
- Cures completely bubble-free

#### Key benefits

- The high mechanical and proven resistance of this sealant ensure a long service life even if exposed to intensive cleaning cycles and aggressive cleaning agents.
- The defect-free curing leads to a very robust and difficult to infringe sealant. The floor stays tight even under heavy loads. Hence, the maintenance costs are lower than with other sealants.

#### Approvals & standards

- ISO 11600 F 12.5 E
- EN 15651, part 4 12.5 E

### Sikaflex® PRO-3

- 1-component non-sag sealant
- 25% movement capability
- High tear and tear propagation resistance
- High stability against a great variety of chemicals
- Cures completely bubble-free

#### Key benefits

- Due to the high movement capability the sealant is able to absorb higher stresses than common floor joint sealants. This significantly reduces the risk of failures and thus reduces maintenance costs as well.
- The excellent tear propagation resistance allows joints to withstand severe mechanical loads even after cuts without any further damages. Hence, the joint's longevity and durability is improved. Costs for maintenance and renovation will be reduced.

#### Approvals & standards

- ISO 11600 25 HM  
EN 15651, part 4 25 HM CC
- ISEGA approval for foodstuff compatibility
- EC-1 Plus approved (very low emissions)
- CSM (Clean Room Suitable Material):  
Very good resistance against mould and bacteria growth according to IPA (ISO 846)





## Construction Details

### Sikaflex® PRO-3 SL

1-component self-levelling sealant

- 25% movement capability
- High tear and tear propagation resistance
- High stability against a great variety of chemicals
- Cures completely bubble-free

#### Key benefits

- The application of this self levelling sealant is surprisingly simple. Without tooling a smooth surface is achieved. The application is quick and efficient.
- The self levelling version of **Sikaflex® PRO-3** shows identical movement capability and tear propagation resistance as the non-sag version and has therefore the same benefits.

#### Approvals & standards

- ISO 11600 25 HM
- EN 15651, part 4 25 HM CC
- ISEGA approval for foodstuff compatibility

For food factories and low loads  
(joint even with the floor)

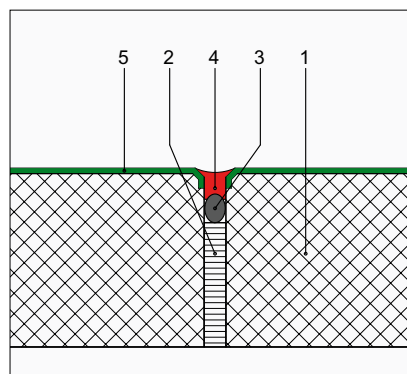

- 1 Concrete slab
- 2 Compression profile
- 3 Backing rod
- 4 **Sikaflex®** joint sealing
- 5 **Sikafloor®** coating

For traffic areas and high loads  
(recessed joint)

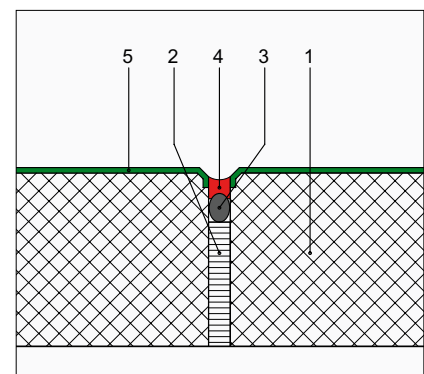

- 1 Concrete slab
- 2 Compression profile
- 3 Backing rod
- 4 **Sikaflex®** joint sealing
- 5 **Sikafloor®** coating

# Sealing Solutions for Floor Joints in Cleanrooms



## General Description & Main Requirements

### What is a Cleanroom?

A cleanroom is an environment typically used for producing something sensitive to contamination.

This environment has a low level of pollutants such as dust, airborne microbes, aerosol particles and chemical vapors.

The trend to improve the cleanliness of manufacturing processes can be witnessed in many industries today, such as:

- Microelectronics
- Photovoltaics and solar panel manufacturing
- Pharmaceutical and biopharmaceutical drug manufacturing
- Medical device manufacturing
- Aerospace and optics.

The cleanroom suitability of materials is an important factor, as equipment and materials have the greatest influence (40%) on product cleanliness.

Suitable materials for cleanrooms possess:

- Low particle emissions
- Low VOC emissions
- Chemical resistance

## Sika Solution

### Sikaflex® PRO-3

1-component non-sag sealant

- Solvent free
- 25% movement capability
- Tested and approved for use in cleanrooms

### Key benefits

- An approved sealant for cleanrooms with the additional advantage of mould and bacteria growth resistance guarantees together with the cleanroom approved **Sika**® coating systems for walls and floors a clean environment. The production process won't be affected from air pollution and the number of rejected goods will be reduced.

### Approvals & standards

- ISO 11600 25 HM, EN 15651, part 4 25 HM CC
- CSM (Clean Room Suitable Material), ISO-AMC class -6.8
- EC-1 Plus approved (very low emissions)
- CSM (Clean Room Suitable Material): Very good resistance against mould and bacteria growth according to IPA (ISO 846)



## Construction Details

For cleanrooms in pedestrian areas and low loads (joint even with the floor)

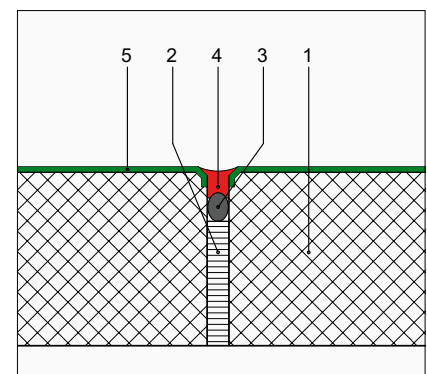

- 1 Concrete slab
- 2 Compression profile
- 3 Backing rod
- 4 **Sikaflex® PRO-3**
- 5 **Sikafloor®** coating



# Sealing Solutions for Floor Joints in Pedestrian Areas



## General Description & Main Requirements

Joints in pedestrian areas should be flush with the surface to prevent injury of people. Therefore a sealant for floor joints in train stations, shopping malls or offices, for example, must fulfil specific requirements. It must:

- Exhibit a sufficiently high hardness
- Show a very high mechanical resistance to allow a surface flush finish without risk of damages
- Be resistant against cleaning fluids and high pressure cleaning

## Sika Solution

### Sikaflex® Floor

- 1-component non-sag sealant
- 12.5% movement capability
- High Shore A hardness
- High mechanical resistance
- Cures completely bubble-free

### Key benefits

- The high mechanical and proven resistance of this sealant ensure a long service life even if exposed to intensive cleaning cycles and aggressive cleaning agents.
- For pedestrian areas flat surfaces with no irregularities are a must. Otherwise there is an increased risk of accidents. The high Shore A hardness and the excellent mechanical properties in general allow such a surface flush joint without any trade-offs on durability

### Approvals & standards

- ISO 11600 12.5 E
- EN 15651, part 4 12.5

## Construction Details

For pedestrian areas with trolley loads (joint even with the floor)

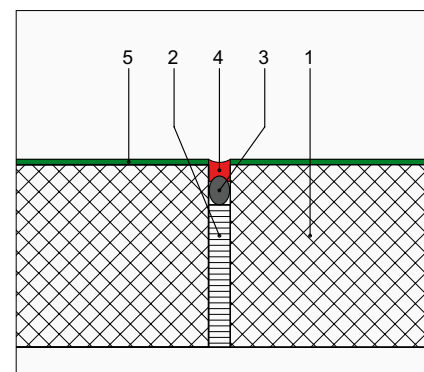

- 1 Concrete slab
- 2 Compression profile
- 3 Backing rod
- 4 **Sikaflex® Floor**
- 5 **Sikafloor®** coating

# Sealing Solutions for Joints in Car Parks



## General Description & Main Requirements

To define the right sealing solution for car park floors it is crucial to consider if it is an intermediate deck or a top deck. A top deck acts also as a roof. Therefore the requirements at the joint construction and the floor coating are much higher than at an intermediate deck without significant outdoor and sunlight exposure.

In car parks floor sealants must especially be able to:

- Resist traffic loads from cars and cleaning machines passing over
- Retain their properties in direct contact with oil and fuel spillages

Additionally, on top decks joints must:

- Be completely waterproof
- Be resistant against weathering
- Accommodate large movements of individual building elements

## Sika Solution

### Sikaflex® PRO-3

1-component non-sag sealant

- 25% movement capability
- High resistance against fuel, oil and road salts
- Trafficable
- Good weatherability

### Key benefits

- For car parks trafficable joints are of great importance. Especially in areas frequented by pedestrians flat surfaces are a must. The excellent mechanical properties allow a surface flush joint without any trade-offs on durability.
- The proven resistance of this sealant against fuel and oil spillage as well as road salts ensure a long service life.

### Approvals/standards

- ISO 11600 25 HM, EN 15651, part 4 25 HM CC
- Resistance against Diesel & Jet fuel – DIBT guidelines
- EC-1 Plus approved (very low emissions)



### Sikaflex® PRO-3 SL

1-component self-levelling sealant

- 25% movement capability
- High resistance against fuel, oil and road salts
- Trafficable
- Cures completely bubble-free

### Key benefits

- The application of this self levelling sealant is surprisingly simple. Without tooling a smooth surface is achieved. The application is quick and efficient.
- The self levelling version of **Sikaflex® PRO-3** shows identical movement capability and chemical resistance as the non-sag version and has therefore the same benefits.

### Approvals/standards

- ISO 11600 25 HM
- EN 15651, part 4 25 HM CC



## Construction Details

For intermediate decks  
For traffic areas (recessed joint)

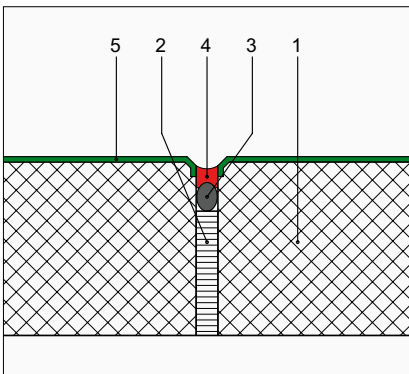

For pedestrian and traffic areas (flush joint)

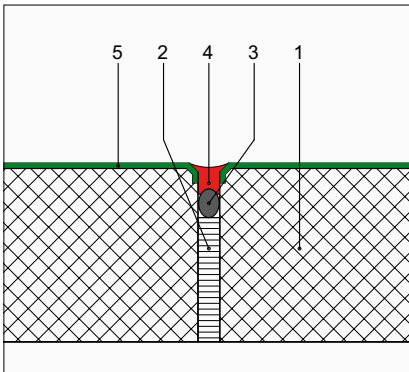

- 1 Concrete slab
- 2 Compression profile
- 3 Backing rod
- 4 **Sikaflex**<sup>®</sup> joint sealing
- 5 **Sikafloor**<sup>®</sup> coating

For top decks and exposed areas (waterproof)

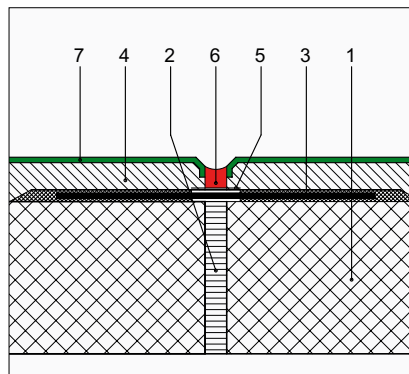

- 1 Concrete slab
- 2 Compression profile
- 3 **Sikadur**<sup>®</sup> **Combiflex**<sup>®</sup> System
- 4 **SikaGrout**<sup>®</sup> or **Sikadur**<sup>®</sup> epoxy mortar
- 5 Separation layer with PE sheet membrane
- 6 **Sikaflex**<sup>®</sup> sealant
- 7 **Sikafloor**<sup>®</sup> coating

For heavy duty crossings (e.g. bridges, ramps)

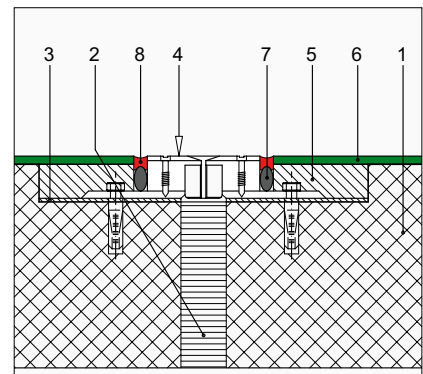

- 1 Concrete slab
- 2 Compression profile
- 3 **Sika**<sup>®</sup> epoxy levelling mortar for the joint transition profile
- 4 Carriageway intersection profile
- 5 Approved **SikaGrout**<sup>®</sup> or **Sikadur**<sup>®</sup> epoxy mortar
- 6 **Sikafloor**<sup>®</sup> coating
- 7 Backing rod
- 8 **Sikaflex**<sup>®</sup> sealant

# Sealing Solutions for Floor Joints in Industrial Kitchens



## General Description & Main Requirements

The use of hot water in industrial kitchens can cause high stress on the floor coverings due to temperature expansion. Elastic sealants help to reduce the forces and prevent the floor from damages. Long-term tightness of connection and movement joints prevents humidity and water passage to other rooms.

Generally, sealants with the following characteristics are needed for industrial kitchen floors:

- High movement capability
- Withstand traffic loads from cleaning machines
- Cleanable with high pressure
- Survive the contact with aggressive cleaning agents and other chemicals
- Compatible with foodstuff

## Sika Solution

### Sikflex® PRO-3

1-component non-sag sealant

- Solvent free
- 25% movement capability
- High stability against a great variety of chemicals
- Tested and approved for foodstuff compatibility
- Low Emission

### Key benefits

- The high mechanical and proven resistance of this sealant ensure a long service life even if exposed to intensive cleaning cycles and aggressive cleaning agents.
- Despite its foodstuff compatibility the sealant is resistant against mould and bacteria growth. This ensures that kitchens meet the legal hygienic requirements.

### Approvals & standards

- ISO 11600 25 HM, EN 15651, part 4 25 HM CC
- ISEGA approval for foodstuff compatibility
- EC-1 Plus approved (very low emissions)
- CSM (Clean Room Suitable Material): Very good resistance against mould and bacteria growth according to IPA (ISO 846)



## Construction Details

Waterproof joint with Sikadur® Combiflex® System

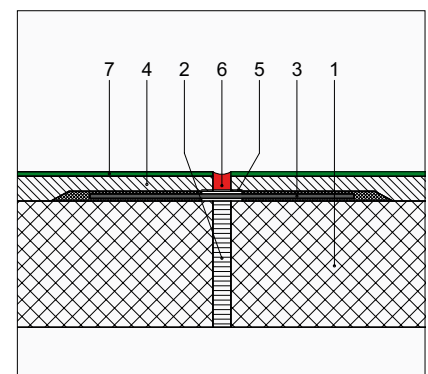

- 1 Concrete slab
- 2 Compression profile
- 3 Sikadur® Combiflex® System
- 4 SikaGrout® or Sikadur® epoxy mortar
- 5 Separation layer with PE sheet membrane
- 6 Sikaflex® PRO-3
- 7 Sikafloor® coating

# Sealing Solutions for Floor Joints on Balconies



## General Description & Main Requirements

Balconies and terraces are exposed to the weather and to high temperature differences therefore the constructions tend to expand and contract. Flexible joint sealants absorb these movements and prevent damages on the floor coatings, e.g. tiles. Tight joints protect adjacent construction elements such as, for example, thermal insulation from water and are therefore an important part of a balcony or a terrace.

The main requirements for a joint sealant on balconies and terraces are:

- High movement capability
- Good adhesion properties to many different materials
- High weatherability
- Resistance against common cleaning agents.

## Sika Solution

### Sikaflex® PRO-3

1-component non-sag sealant

- 25% movement capability
- Odourless during application and thereafter
- Good weatherability

### Key benefits

- Since the product is completely odourless the inconvenience for residents especially in case of renovations is negligible.
- The good weatherability ensures a long service life and thus reduces maintenance and renovation costs.

### Approvals & standards

- ISO 11600 25 HM, EN 15651, part 4 25 HM CC
- EC-1 Plus approved (very low emissions)
- CSM (Clean Room Suitable Material): Very good resistance against mould and bacteria growth according to IPA (ISO 846)

### Additional product alternative:

- **Sikaflex Floor:**  
1-component, non-sag sealant with a very good price-performance ratio.



## Construction Details

Waterproof connection joint to the façade with Sikadur® Combiflex® System

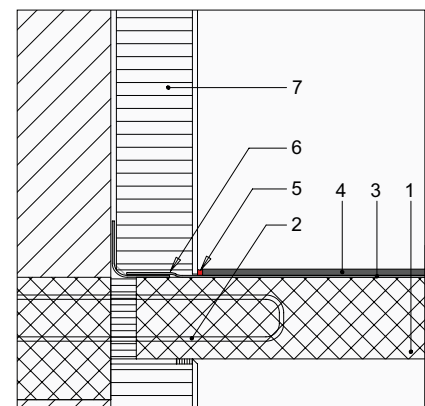

- 1 Concrete slab of balcony
- 2 Connection reinforcement for balcony plate
- 3 Waterproofing System e.g. with **Sikalastic®** or **Sikafloor®**
- 4 Covering e.g. with tiles or **Sikafloor®**
- 5 **Sikaflex®** joint sealing with PE strip
- 6 Waterproof connection to the façade e.g. with **Sikadur® Combiflex®** System
- 7 Insulation

# Sealing Solutions for Specialty Joints in Containment Bunds and Petrol Stations



## General Description & Main Requirements

Proper joint sealants help to protect the environment, especially the ground water against contamination in areas for the storage and handling of aggressive chemicals and water polluting liquids, such as:

- Petrol stations
- Storage areas in the chemical industry
- Containment bunds
- Barrel stores etc.

The main requirements for a joint sealant in such applications are:

- Fuel and oil resistance
- High resistance against various other chemicals
- High mechanical resistance
- Conformance to legal requirements and governmental regulations

## Sika Solution

### Sikaflex® Tank N

1-component non-sag sealant

- Good tear resistance
- 25% movement capability
- High resistance against fuel, oil, hydrocarbons and other chemicals
- Bubble free curing

### Key benefits

- Unlike most joint sealants for these applications **Sikaflex® Tank N** is a ready to use 1-component product. This means mixing errors that may lead to faulty installation with severe consequences regarding soil and groundwater pollution do not occur. In addition one component products allow a much faster application and produce less waste.
- Hydrocarbons are frequently used in various industries and sealants surviving hydrocarbon exposure are in great demand. **Sikaflex® Tank N** is optimized to resist such chemicals and provides the necessary security against environmental contamination.

### Approvals & standards

- European Technical Approval for joint-sealing systems in areas for the storage, filling and handling of water polluting liquids (ETA-09/0272)



## Construction Details

For connection joints between concrete slabs

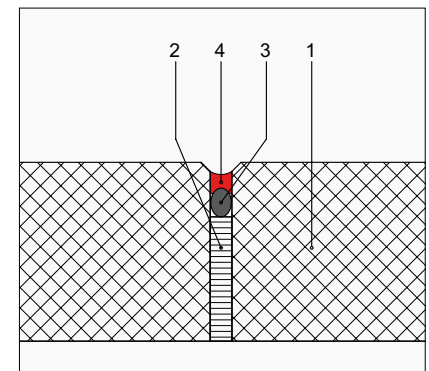

- 1 Concrete slab
- 2 Compression profile
- 3 Backing rod
- 4 **Sikaflex® Tank N**

# Sealing Solutions for Specialty Joints in Sewage Treatment Plants



## General Description & Main Requirements

Sealants used in sewage treatment plants have to survive extremely harsh conditions and thus must meet very demanding requirements. Only sealants specifically designed for this environment are suitable.

## Sika Solution

### Sikaflex® PRO-3

1-component non-sag sealant

- High resistance against waste water and waste water treatment chemicals
- Excellent adhesion under permanent water immersion
- Resistance against microbiological attack
- Resistance against continuous high water pressure

### Key benefits

- **Sikaflex® PRO-3** provides durable adhesion and longevity even under permanent water immersion and high water pressure. In addition the sealant is virtually not affected by residential waste water and microorganisms. This durable solution reduces down times of sewage treatment plants.

### Approvals & standards

- ISO 11600 25 HM, EN 15651, part 4 25 HM CC
- CSM: Very good resistance against mould and bacteria growth according to IPA (ISO 846)
- Waste water resistance according to the DIBt guidelines (German approval body for construction products and types of construction)



## Construction Details

For connection joints between concrete slabs with a high demand on tightness

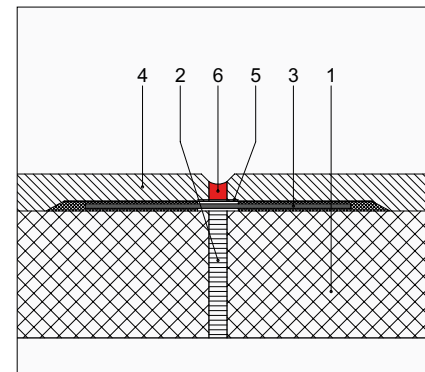

- 1 Concrete slab
- 2 Compression profile
- 3 **Sikadur® Combiflex®** System
- 4 **SikaGrout®** or **Sikadur®** epoxy mortar
- 5 Separation layer with PE sheet membrane
- 6 **Sikaflex® PRO-3**

# Sealing Solutions for Specialty Joints in Airfields, Taxiways and Aprons



## General Description & Main Requirements

Airfield sealants are applied between concrete slabs to seal out moisture and debris from joints on airport runways and taxiways.

The most important requirements for an airport sealant are:

- All-temperature adhesion & flexibility
- Resistance to heavy equipment traffic from airplanes, maintenance vehicles and trucks
- Resistance to aggressive chemicals like jet fuel and de-icing agents.

## Sika Solution

### Sikaflex®-68 TF

2-component self-levelling sealant

- Good tear resistance and flexibility
- Oil and Jet fuel resistance

### Key benefits

- The application of this self levelling sealant is very simple. Without tooling a smooth surface is achieved. The application is quick and efficient.
- **Sikaflex®-68 TF** is designed to resist jet fuel and other chemicals and provides the necessary security against environmental contamination.

### Approvals & standards

- Meets most relevant requirements of US Federal Specification SS-S-200E

## Construction Details

For connection joints between concrete slabs

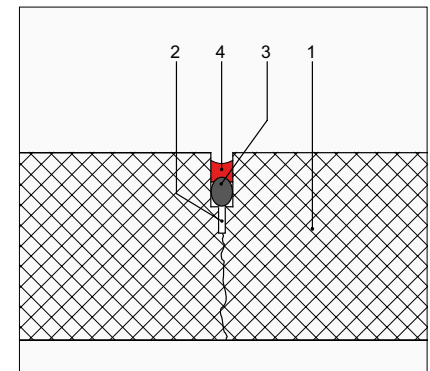

- 1 Concrete slab
- 2 Saw cut
- 3 Backing rod
- 4 **Sikaflex®-68 TF**



# Sealing Solutions for Joints in Concrete Pavements



## General Description & Main Requirements

To achieve a long-lasting high quality of road paving, suitable construction materials including high-performance joint sealants (e.g. for road pavements and bridges) are key.

The main requirements for a highway joint sealant are:

- High movement capability for extremely high and low temperature conditions
- Durability under all weather conditions to minimize maintenance costs

## Sika Solution

### Sikasil®-728 SL

1-component self-levelling sealant

- +100/-50% movement capability
- Very low modulus
- Excellent UV resistance
- Resistant against road salt and fuel spillage

### Key benefits

- Due to the high movement capability and very low modulus the sealant is able to absorb movements with extremely low stresses on the adhesion interfaces. This increases the longevity of the joints and secures the tightness.
- The sealant does not degrade by direct sunlight exposure and can be used in hot and cold climates without significant impact on the mechanical properties.

### Approvals & standards

- Meets requirements of ASTM D-5893; ASTM C-920, Type S, Grade NS, Class 100/50, Use NT, T,M,G, A,O with an ultra low Shore Hardness; TT-S-00230C, Type II, Class A; TT-S-001543A, Class A.

### Additional product

#### ■ Sikasil®-728 NS

Non-sag, one-component, ultra low modulus, elastomeric sealant

## Construction Details

For connection joints between concrete slabs (recessed joint)

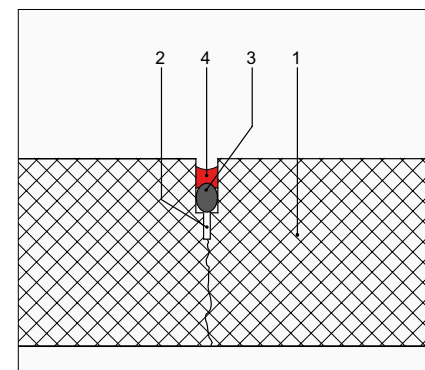

- 1 Concrete slab
- 2 Saw cut
- 3 Backing rod
- 4 Sikasil®-728 SL/NS

# Sealing Solutions for Specialty Joints for Silos and Tanks in Biogas Plants



## General Description & Main Requirements

Proper joint sealants help to protect the environment, especially the ground water against contamination in areas for the storage and handling of silage, liquid manure and agricultural waste especially. Such sealants also play a key role in the construction of digesters nowadays used in many communities to produce energy. Typical application areas for these highly resistant products are:

- Biogas plants
- Storage areas for biowaste
- Agricultural tanks and silos etc.

Sealants used in these areas must have:

- High resistance against various chemicals and silage
- High mechanical resistance and flexibility

## Sika Solution

### Sikaflex® TS Plus

1-component non-sag sealant

- Resistant to domestic sewage, silage, liquid manure and numerous chemicals including acids
- High tear resistance and flexibility
- High modulus, elastic sealant

### Key benefits

- **Sikaflex® TS Plus** is designed to resist organic acids which are produced in every digesting process and other chemicals and provides the necessary security against leakages and thus ensures a longer lifetime for silos and tanks.

### Approvals & standards

- Testing in accordance with the specification and principles of DIBt (German approval body for construction products and types of construction) for wastewater exposure
- Conforms to BS 6920 (drinking water contact)

## Construction Details

Gasket sealants for bolted steel tanks

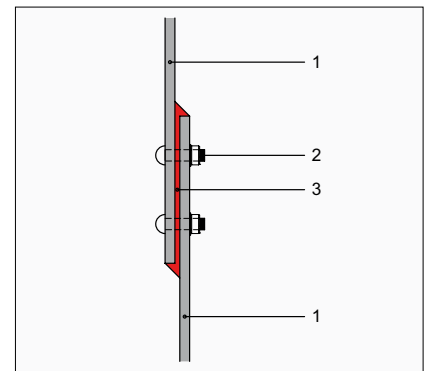

- 1 Steel plates
- 2 Bolt with protection
- 3 **Sikaflex® TS Plus**

# Further Sika Solutions for Joints and Connections

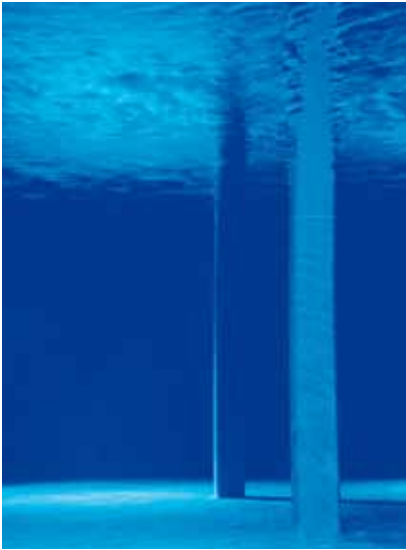

## Sealing Solutions for Joints in Drinking Water Facilities

### Main Requirements

For joints in contact with potable (drinking) water, e. g. in drinking water reservoirs, tanks, treatment and filtration plants, sealants must not have a negative influence on the water quality.

The main requirements for a joint sealant in drinking water reservoirs are:

- Approvals according to the local regulations for use in drinking water facilities
- Resistance to chlorine-based and other disinfection agents
- No toxic ingredients
- Not metabolisable
- Good adhesion to a great variety of substrates while immersed in water

### Sikaflex® PRO-3

1-component non-sag sealant

- Tested and approved for drinking water contact according BS 6920 (British drinking water approval)
- Excellent adhesion under permanent water immersion
- Resistance against continuous high water pressure



### Sikasil® DW

1-component non-sag sealant

- Tested and approved for drinking water contact according DVGW W270 (German Federal drinking water approval) and conforms to the KTW recommendations of the German Federal Board of Health
- Excellent water and chlorine-based disinfectant resistance
- High resistance to growth of fungi



## Sealing Solutions for Joints in Swimming Pools

### Main Requirements

Joint sealing around and in swimming pools is due to the forbidding conditions for sealants one of the most difficult joint sealing applications.

The main requirements for a joint sealant in swimming pools are:

- Excellent UV stability
- High chlorine-based disinfectant resistance
- High durability while permanently immersed in water
- Mildew and fungus resistance

### Sikasil® Pool

1-component non-sag sealant

- High tear resistance and flexibility
- Excellent UV stability and weather resistance
- Excellent stability in water
- Extremely high resistance to fungal attack
- High resistance to chlorine-based disinfectants
- Non-corrosive



## Sika Solutions for Flexible Rail Fixing

### Main Requirements

Long-lasting, flexible, direct fixation of rails to solid substrates is suitable for a variety of track work designs like railway, light rail, tram and crane track installations.

The main advantages for these types of flexible direct fixations are:

- Levelling out of inevitable tolerances between rail and substrate
- Highly efficient electrical insulation for prevention of stray current
- Resilient intermediate layer for optimum reduction of noise and vibration transmission
- Powerful adhesive for added safety and maximum performance

### Icosit® KC-330 and -340 Series

2-component, elastic, self levelling grouts for direct fixations of steel plates and for continuous embedding of rails

- Long durability, less maintenance
- Less wear on rolling stock
- Elastic and shock absorbent
- Insulation against leakage of stray currents
- Reliable track alignment (height adjustable)
- Reduction of vibration and mechanical wear (rail and rolling stock)
- Strong bond between rail and substrate
- Elastic and shock absorbent

# More Construction Details

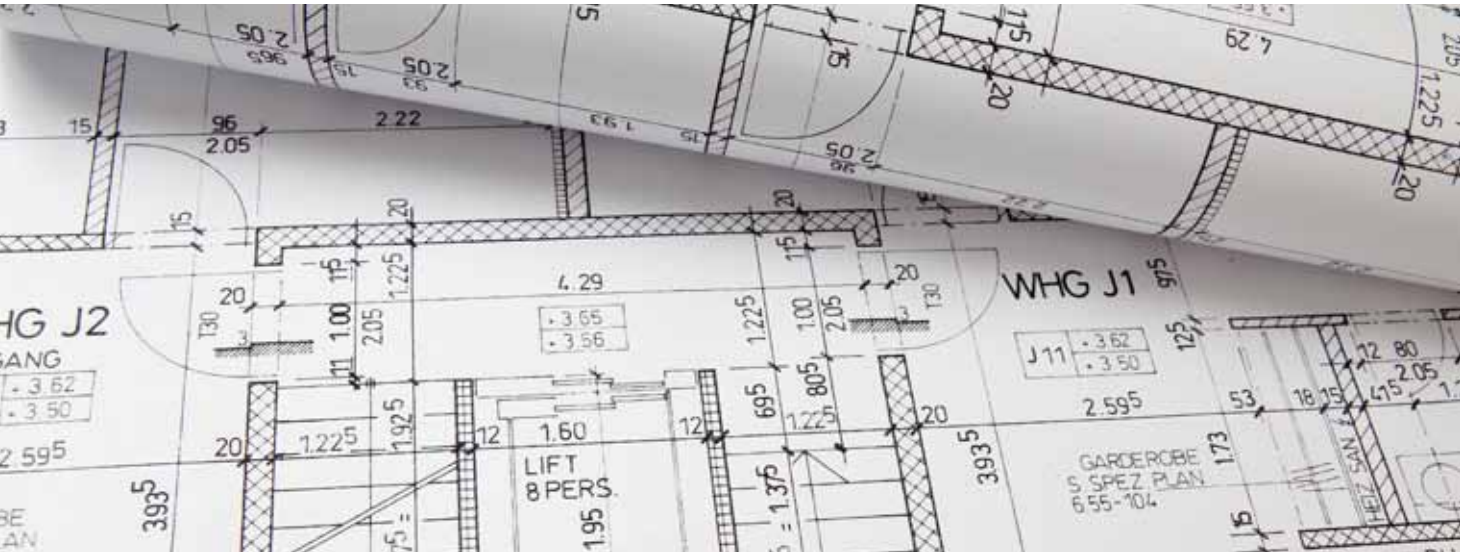

## Construction Details

For connection joints between wall and floor  
(for dry areas)

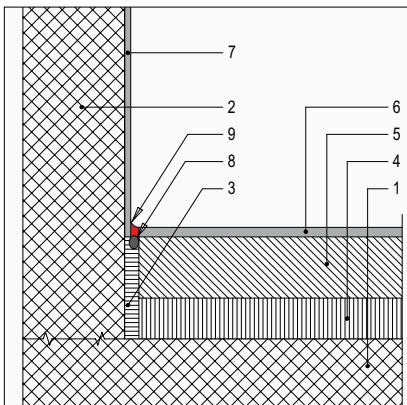

- 1 Concrete slab
- 2 Concrete (or brick) wall
- 3 Compression profile
- 4 Thermal insulation
- 5 Cementitious floor screed
- 6 Floor covering (e.g. **Sikafloor**<sup>®</sup> or tiles etc.)
- 7 Wall covering (e.g. **Sikagard**<sup>®</sup>, **Sikafloor**<sup>®</sup> or plaster etc.)
- 8 Backing rod
- 9 **Sikaflex**<sup>®</sup> joint sealing

For for connection joint to a steel gutter  
(mainly inside)

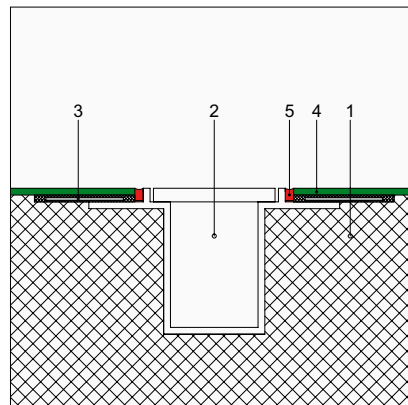

- 1 Concrete slab
- 2 Steel gutter
- 3 Waterproof connection e.g. with **Sikadur**<sup>®</sup> **Combiflex**<sup>®</sup> System
- 4 **Sikafloor**<sup>®</sup> coating or tiles
- 5 **Sikaflex**<sup>®</sup> joint sealing with PE strip

For connection joint to a concrete gutter  
(mainly outside)

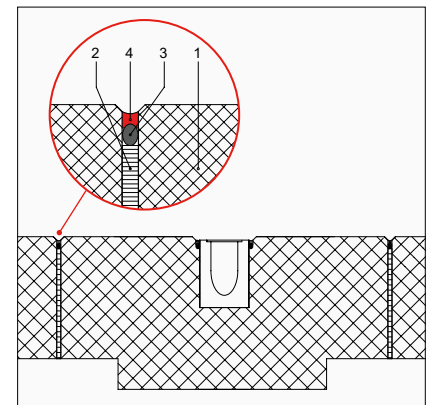

- 1 Concrete slab
- 2 Compression profile
- 3 Backing rod
- 4 **Sikaflex**<sup>®</sup> joint sealing

# Surface Pre-Treatment Products for Sealants



## General Description & Main Requirements

Many Sika sealants exhibit excellent adhesion to a great variety of substrates. In order to build up sufficient adhesion the substrate surface must be clean, dry and free from any grease, oil, dust, release agents and any other substances that potentially could have a negative influence on the adhesion. Sika's cleaners and activators are products that help to achieve such an ideal surface for perfect adhesion results. Primers enhance the adhesion on difficult to adhere substrates such as certain plastics and significantly improve the long-term adhesion especially under severe conditions.

## Pre-Treatment Solutions

### **Sika® Aktivator-205**

is a 1-component alcohol-based cleaner containing adhesion promoters. The product is used to activate non-porous substrates such as metals, plastics, glazed ceramics and various painted surfaces.

### **Sika® Primer-3 N**

is a 1-component epoxy-based primer that improves the long-term adhesion of sealants to porous, absorbent materials such as concrete, but also on metals.

### **Sika® Primer-215**

is a 1-component polyurethane based primer that improves long-term sealant adhesion to plastics, varnishes, lacquers and even porous materials. A typical application where **Sika® Primer-215** would be used for substrate pre-treatment is perimeter sealing between vinyl or powder-coated aluminium window frames and brickwork.

### **Sika® Primer-115**

is a 1-component polyurethane based primer that improves the long-term adhesion of the sealant **Sikaflex®-68 TF** to porous, absorbent materials such as concrete.



# Joint Design Principles and Specification



## General Requirements

The design of a sealing system involves more than just the selection of a sealant with suitable physical and chemical characteristics. In order to obtain a long-term optimal performance the following considerations are essential as well:

- Proper joint design, including correct dimensioning and backup
- Type and nature of substrates
- Application process and ambient conditions at the time of the installation

Movement capability of the sealant and joint width must fit to the expected movement of the adjacent building elements.

The optimal ratio of joint width to depth (sealant thickness) is 1:1 for floor joints. Accordingly, the recommended joint dimensions for concrete elements and a sealant with 25% movement capability are as follows:

### Interior Floor Joints

Joint distance (m)	2	3	4	5	6	8
Minimum joint width (mm)	12	12	12	12	12	12
Sealant thickness (mm)	12	12	12	12	12	12

### Exterior Floor Joints

Joint distance (m)	2	3	4	5	6	8
Minimum joint width (mm)	12	12	15	18	20	30
Sealant thickness (mm)	12	12	12-15	15	17	25

Depending on the loads and location special design considerations for floor joints are necessary. Joints in areas with a lot of car and/or equipment traffic should be recessed to reduce wear and tear. On the other hand, joints in pedestrian areas should be flush with the surface to prevent injury of people.

### High traffic floor joints (Sealant is recessed)

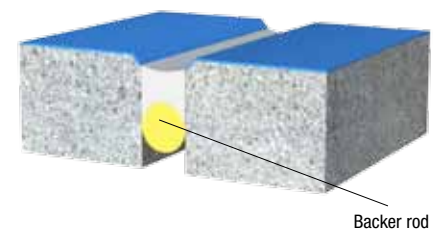

Backer rod

### Pedestrian area floor joints (Sealant is on floor level)

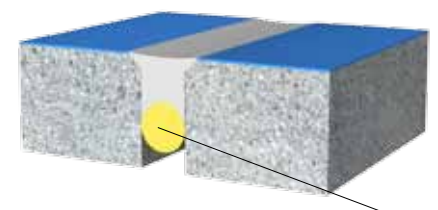

Backer rod

Due to these many different requirements sealants should be specified thoughtfully. Sika supports you in determining a fitting solution that meets all requirements, has all mandatory approvals and the expected lifetime.

# Standards & Approvals



Industry-wide sealant standards, standard specifications and guidelines ensure that the sealants show the properties which are required and are also useful as tools to educate the designer, user and installer.

## Standards

There are a great number of international, regional and local standards covering construction sealants. Most of them classify the sealants after their application (use), movement capability, secant tensile modulus and type (1- or 2-part sealant).

The most important standards are:

- ISO 11600**  
 “Building construction – Jointing products – Classification and requirements for sealants” by International Organization for Standardization.

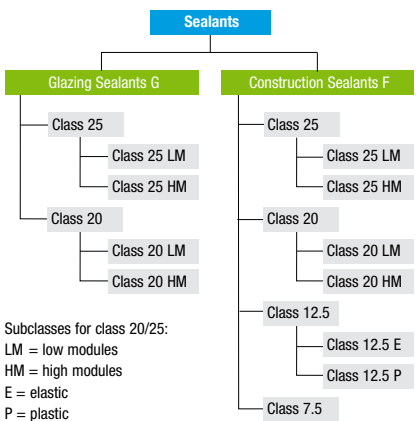

- JIS A 5758**  
 Japanese JIS standard A 5758 for sealing and glazing in buildings is based upon the principles of ISO 11600 and provides a classification of sealants according to their movement capability and modulus. Contrary to ISO 11600 the JIS standard defines an additional class “30S” (S indicates shearing) for glazing sealants.
- ASTM C 920**  
 “Standard Specification for Elastomeric Joint Sealants” by ASTM International, formerly known as the American Society for Testing and Materials.

- EN 15651**  
 European Norm for “Sealants for nonstructural use in joints in buildings and pedestrian walkways”.

## Guidelines

In addition sealants have to fulfil specific guidelines depending on their application. Not all of them are mandatory, but the following enumeration should give an overview about the most common ones:

- Chemical resistance**  
 DIBt (German approval body for construction products and types of construction) guideline for wastewater exposure
- Cleanroom**  
 CSM cleanroom suitable material (Fraunhofer Institut, Germany)
- Food industry**  
 ISEGA approval for foodstuff compatibility
- Drinking Water**  
 British standard 6920 (drinking water contact)
- Low emission**  
 GEV Emicode, AgBB, etc.

Especially floor joints have to withstand severe conditions. Hence it is necessary to specify sealants thoughtfully.

For further information, approvals and references from our products please contact our Technical Service.

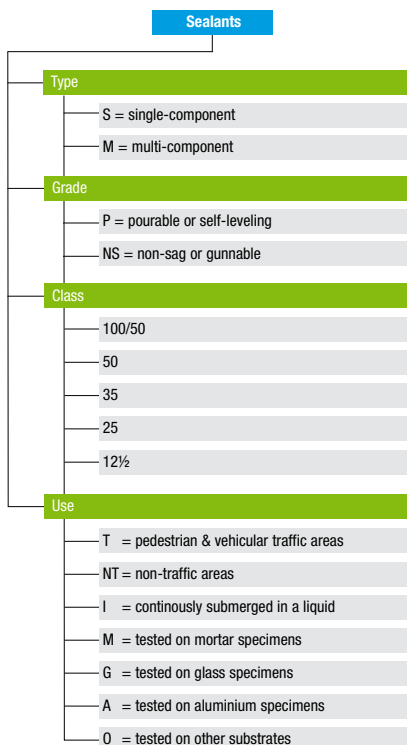

# Application Matrix

## For Highly Resistant Joint Sealants

Application fields	Sikaflex® Floor	Sikaflex® PRO-3	Sikaflex® PRO-3 SL	Sikaflex® TS plus	Sikaflex® Tank N	Sikaflex®-68 TF	Sikasil®-728 Range	Sikadur® Combiflex
	1-comp. non-sag sealant	1-comp. non-sag sealant	1-comp. self-leveling sealant	1-comp. non-sag sealant	1-comp. non-sag sealant	2-comp. self-leveling sealant	1-comp. non-sag or self-leveling sealant	2 comp. EP-Adhesive with Sikadur® Combiflex® stripe
Indoor	••	••	••	••	••	•	•	••
Outdoor	•	••	••	••	••	••	••	••
Pedestrian areas with trolley load e.g. warehouses shopping areas	••	•	•		•	•		•
Traffic loads, car parks	•	••	••		•	•		•
Traffic loads, airfields, taxiways, aprons		•	•		•	••	•	•
Traffic loads, light industry	••	•	•		•	•		•
Traffic loads, heavy industry		••	••		•	•		•
Traffic loads, highways					•		••	•
Temporary oil and fuel resistant		•	•	•	••	•	•	•
High pressure cleaning possible	•	•	•	•	•	•		•
Temporary solvent resistant		•	•	•	••	•		•
Use on balconies		••						•
Use in industrial kitchen		••	•					•
Use for biogas plants with silage and liquid manures				••				
Use in food industry	•	••	••					•
Use for cleanroom, semi-conductors etc.		••						
Use in chemical industry		•	•		••	•		•
Use in sewage treatment plants		••	•	••				•
Use in waste water tubes		••			•			•
Use in drinking water facilities		••						
Use in containment bunds		•	•		••			•
Use in filling station		•	•		••	•		•

•• recommended    • possible    without red dot, not recommended





# Sikadur-Combiflex® SG System

## High Performance Joint and Crack Waterproofing System



The **Sikadur®-Combiflex® SG** system is the second generation development of the globally proven **Sikadur-Combiflex®** with even improved performance such as advanced adhesion properties and drinking water approval. The unique system consists of the **Sikadur-Combiflex® SG** tape and the **Sikadur®** adhesives. It is widely used as joint waterproofing in watertight concrete structures.

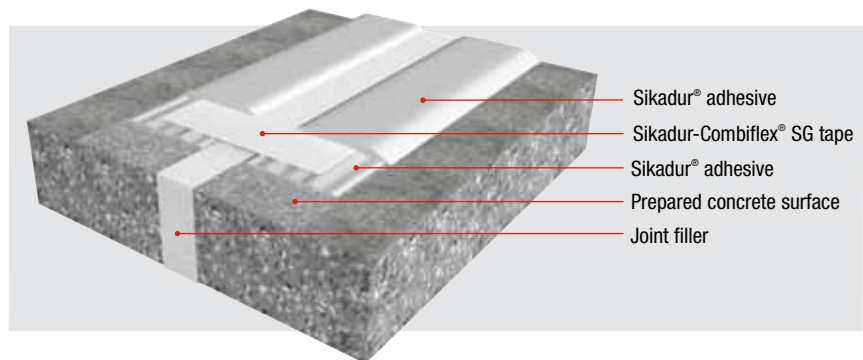

### Function:

- Blocking the path of water penetration
- Increased length of water penetration
- Fully bonded to the concrete preventing underflow

### Main Advantages

- Waterproofing of joints with extreme movements
- Easy to install and adjust to complicated construction details
- Excellent adhesion to different substrates
- Resistant to high water pressure
- Crack sealing system
- Easy to control and repair

### Examples of Application



#### Sewage Treatment Plants

- Resistance to sewage water
- Good abrasion resistance
- Independent of concreting steps
- High joint movement capacity



#### Ground Water Protection

- Chemical resistant
- High safety of environment
- Impermeable



#### And a lot more:

**Bridges, park decks, basements, reservoirs etc.**

- Flexible to joint tolerances
- High water- and air tightness and durability
- De-icing salt resistance
- Resistance to ozone, chlorine and UV
- Approved in contact with drinking water

# Solutions for Joint Renewal and Repair



## General Description

### Reasons for joint repair

A careful visual inspection is usually enough to determine if the joint sealing is improper or worn out and a replacement is needed.

Reasons for joint refurbishment may include but are not limited to the following:

- Failures in workmanship
- Use of unsuitable type of sealant
- Wrong joint design
- Underestimated load
- Sealant reached end of its life cycle
- Compatibility issues with adjacent materials (e. g. gaskets)
- Exposure to aggressive chemicals
- Insufficient surface preparation (loss of adhesion)



## Sealing Solutions

### Renovation in case of insufficient pre-treatment or a sealant at the end of its normal life cycle

An old sealant needs to be renovated at the end of a normal life cycle or because of maintenance or quality insufficiency reasons. Usually such joint renovation is done with gunnable sealants.

Check first the reason why the old sealant failed and the compatibility of the old sealant with the sealant intended to be used as replacement. If in doubt contact your Sika representative. If the old sealant is based on polyurethane, silane-terminated polymers (hybrids, MS, etc.) or polysulfide it can be replaced with a suitable **Sikaflex**® sealant. If the originally used joint sealant is a silicone it must be repaired with a suitable **Sikasil**® silicone sealant.

To start renovating the joint pick or cut out the old or damaged sealant using, for example, an oscillating knife or similar tools. In areas with adhesion loss, mechanical cleaning of the bonding area is not only very important but mandatory.

In order to ensure long term durability and tightness of the newly sealed joint both the substrate surfaces as well as the old sealant remains should be pretreated using the primer recommended by Sika.

### Renovation in case of wrong joint dimensioning

In this case it will not be useful to renew the sealant with similar dimensions as the original joint or a sealant with similar mechanical properties again, because the damage is likely to re-occur.

There are two possible solutions available for renovating a floor or specialty joint. One can use a sealant with higher movement capability like ① **Sikaflex**® **PRO-3** with +/-25% movement capability the joint width must be increased until the sealant is able to accommodate the occurring movements.

If the joint is widened the joint edges must be renewed properly. Depending on the floor covering ② **Sika**® **MonoTop**® repair mortars, **Sikadur**® epoxy-grouts or -mortars or **Sikafloor**® **EpoCem**® mortars can be used.

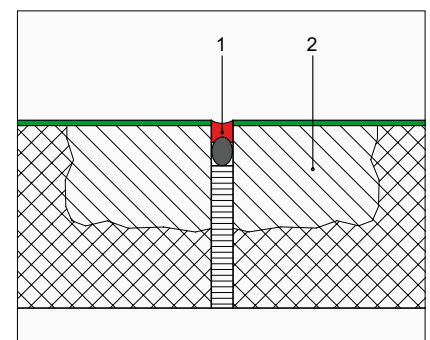

# Sika Sealing Solutions Contribute to a Sustainable Future



Sika is committed to putting high-performance solutions into practice – to the benefit of our customers and for a sustainable development.



## Sika Sealing Solutions enable to produce Renewable Energy

- For companies producing energy with wind turbines it is crucial to have a durable infrastructure with long maintenance cycles especially for off shore plants. Long-lasting Sika sealants ensure the tightness of the generator housings even under severe weather conditions on sea and seal the joints in concrete segment columns to prevent water penetration and consequent frost damage.
- The use of agricultural waste to produce energy through biogas is one important and fast growing branch of the renewable energy business. To store the biological waste, tight silos and containers are needed. Sealants from Sika enable impermeable constructions and help to build cost efficient facilities.



## Sika Solutions help to Protect Water

- The cleaning of waste water in mature as well as emerging countries is of great importance. Drinking water is one of the most important resources that needs protection. Sika provides different tailor-made solutions for drinking water storage and waste water treatment including sealants, coatings and waterproofing systems. All of them exhibit a long service life even under permanent water immersion and resist aggressive liquids used in water treatment plants. This ensures a long life expectancy of such facilities.
- Sika provides sealants with an outstanding chemical resistance for sealing of containment bunds. The resistance of the sealant ensures in case of an accident the tightness of the containment bund for a longer time than usual sealants would do. Hence, the emergency services gain time to pump the aggressive chemicals into secure containers and the risk to contaminate ground or drinking water is significantly reduced.



## Sika Solutions help to Protect Air

- Sika provides solvent free sealants with low emission and low or no volatile organic compounds (VOC) and hence, ensures secure and healthy surroundings for the contractor during the application and an emission free and clean air for the user of the building.



# Sika Full Range Solutions for Construction

## Concrete Production



**Sika® ViscoCrete®**  
**Sika® Retarder®**  
**Sika® SikaAer®**

## Waterproofing



**Sikaplan®, Sikalastic®**  
**Sika® & Tricosal® Waterstops**  
**Sika® Injection Systems**

## Flooring



**Sikafloor®**  
**SikaBond®**

## Corrosion and Fire Protection



**SikaCor®**  
**Sika® Unitherm®**

## Concrete Repair and Protection



**Sika® MonoTop®**  
**Sikagard®**  
**Sikadur®**

## Structural Strengthening



**Sika® CarboDur®**  
**SikaWrap®**  
**Sikadur®**

## Joint Sealing



**Sikaflex®**  
**Sikasil®**

## Grouting



**Sikadur®**  
**SikaGrout®**

## Roofing



**Sarnafil®**  
**Sikaplan®**  
**SikaRoof® MTC®**

## Also Available from Sika



**Sika Services AG**  
 Business Unit Contractors  
 Speckstrasse 22  
 CH-8330 Pfäffikon  
 Switzerland  
 Phone +41 58 436 23 80  
 Fax +41 58 436 23 77  
 www.sika.com

Our most current General Sales  
 Conditions shall apply.  
 Please consult the Product Data Sheet  
 prior to any use and processing.

